



Telescopio Nazionale Galileo

HARPS-N USER MANUAL

Version 3.1

TNG-MAN-HARPN-0002

Date: 05-01-2022

Prepared

R. Cosentino

Change Record

Issue/Re v.	Date	Section/Page affected	Reason/Remarks
V1.0	24-04-2012	First version	
V1.1	18-01-2013	First revision	
V1.2	28-01-2013	changes	
V2.0	14-02-2013		New sequencer
V2.1	11-03-2013		
V2.2	16-04-2013	Some tables and fig. changed	New CCD and readout
V2.3	15-10-2013	Some tables and fig. changed	
V2.4	13/12/2016		General upgrade
V3.0	13/03/2020		New LCU and AG software
V3.1	05/01/2022	§ 2.6	New DRS installed

Contents

1	Introduction	6
1.1	Scope	6
1.2	Additional information.....	6
1.3	Contact information	6
1.4	Reference documents	6
1.5	Acknowledgments.....	7
2	HARPS-N Characteristics.....	8
2.1	Instrument Overview	8
2.1.1	Instrument coupling to the telescope	10
2.2	Operational overview.....	11
2.2.1	Fiber link.....	11
2.2.2	Calibration unit (CU)	11
2.2.3	Front End Unit (FEU)	12
2.3	Detector and read out electronics	14
2.3.1	General detector characteristics	14
2.3.2	CCD.....	14
2.3.3	Cryostat	15
2.3.4	CCD controller	15
2.3.5	Shutter	15
2.3.6	Exposure meter	15
2.4	Software architecture	16
2.5	Data acquisition software.....	16
2.5.1	Short Time Scheduler (STS).....	16
2.5.2	Sequencer	17
2.5.3	Front End Unit, Autoguider and Calibration Unit control (instrument software).....	17
2.5.4	Telescope Control System	17
2.6	Data Reduction Software	19
2.7	HARPS-N performances.....	21
2.7.1	Spectral format and resolution	22
2.7.2	Efficiency of the spectrograph.....	23
2.7.3	Instrumental stability and simultaneous reference	25
2.7.4	On-sky precision	26
3	Observing modes.....	28
3.1	Simultaneous Thorium reference method.....	28
3.1.1	Performance	28
3.1.2	Calibrations	28
3.1.3	Observations.....	30
3.1.4	Pipeline, data reduction.....	30
3.2	Simultaneous Fabry Perot reference method.....	30

3.2.1	Performance	30
3.2.2	Calibrations	30
3.2.3	Observations.....	31
3.2.4	Pipeline, data reduction.....	31
3.3	Classical fibre spectroscopy	31
3.3.1	Performance	31
3.3.2	Calibrations	31
3.3.3	Observations.....	31
3.3.4	Pipeline, data reduction.....	31
3.4	Focusing of the telescope.....	32
3.4.1	Performance	32
3.4.2	Template.....	32
3.5	RV Accuracy.....	32
3.5.1	Photon noise	32
3.5.2	Telescope focus.....	32
3.5.3	Centering errors.....	32
3.5.4	Thorium calibration errors	32
4	Preparing the observations	33
4.1	Introduction.....	33
4.2	Introducing Observing Blocks	33
4.2.1	Observing blocks.....	33
4.2.2	Science templates.....	33
4.2.3	Calibration templates	34
4.2.4	Technical templates	34
4.2.5	New Short Time Scheduler (NSTS)	34
4.3	Overheads.....	36
4.3.1	Fast time series observations (asteroseismology).....	36
4.4	The HARPS-N Exposure Time and Spectral Format Calculator	36
5	Observing with HARPS	38
5.1	The Observation blocks preparation	38
5.2	Before the night.....	38
5.3	During the night	38
5.3.1	Target acquisition, guiding, focusing	38
5.3.2	Pointing restrictions	39
5.3.3	Night calibrations.....	39
5.3.4	Real-time display	39
5.4	Observing very faint stars.....	39
5.5	Asteroseismology.....	39
5.6	End of the night.....	40
6	The Reduction of HARPS-N Data.....	41
6.1	The HARPS-N data reduction pipeline	41

6.2	High accuracy radial velocities	41
7	Data products and archiving	42
7.1	Data products	42
7.1.1	Raw data file	42
7.1.2	Reduced data file.....	42
7.2	Data archiving.....	43
7.2.1	TNG and Trieste archives	43
7.2.2	TNG data logging.....	43
7.2.3	Use of archived HARPS-N data	44
A.1	Data naming rules	46
A.2	Data formats	46

1 Introduction

1.1 Scope

This User Manual is intended to give all necessary information to potential users of the HARPS-N instrument, to help them decide on the opportunity to use the instrument for their scientific applications, to be used as a reference when writing observing proposals and when preparing the observations.

For this purpose, we give

- An overall description of the HARPS-N instrument, its performance and its observing modes;
- Information on the preparation of the observations;
- Information on the observing process;
- A description of the HARPS-N data and near real-time pipeline data reduction

The following documents are closely related to this manual and should be consulted as well:

HARPS-N Quick Start Guide (TNG-MAN-HARPN-0001)
HARPS-N Operational Guide (TNG-MAN-HARPN-0003)
HARPS-N LCU Manual (TNG-MAN-HARPN-0004)
HARPS-N Autoguide Manual (TNG-MAN-HARPN-0005)
HARPS-N DRS User Manual (TNG-MAN-HARPN-0006)
New Short Term Scheduler User Manual (NSTS)
DRS User Manual (OG-MAN-HAN-13-0004)
Ucam User manual
Templates Reference Guide
Thorium-Argon Atlas

These manuals are available through the TNG web page

<http://www.tng.iac.es/instruments/harps/>

1.2 Additional information

The latest information updates about the HARPS-N instrument can be found on the HARPS-N web pages

<https://plone2.unige.ch/HARPS-N/harps-n-operations-and-observations>

1.3 Contact information

Feedback on this User Manual from users is encouraged. Please email to cosentino@tng.iac.es

1.4 Reference documents

- [RD01] HARPS-N Quick Start Guide (TNG-MAN-HARPN-0001)
- [RD02] HARPS-N Operational Guide (TNG-MAN-HARPN-0003)
- [RD03] HARPS-N LCU Manual (TNG-MAN-HARPN-0004)
- [RD04] New Short Term Scheduler User Manual (NSTS)
- [RD05] DRS User Manual (OG-MAN-HAN-13-0004)
- [RD06] Ucam User manual
- [RD07] Templates Reference Guide
- [RD08] Thorium-Argon Atlas
- [RD09] HARPS-N Autoguide Manual (TNG-MAN-HARPN-0005)
- [RD10] HARPS-N DRS User Manual (TNG-MAN-HARPN-0006)

1.5 Acknowledgments

Most of the contents of this manual is based on information from the HARPS-N Consortium (Astronomical Observatory of the Geneva University (lead), the Harvard-Smithsonian Center for Astrophysics in Cambridge (USA), the Universities of St. Andrews and Edinburgh, the Queens University of Belfast, and the TNG-INAF Observatory).

Releases of this document are based on the ESO HARPS User Manual edited by G. Lo Curto.

Feedback on this User Manual from users is encouraged. Please email to cosentino@tng.iac.es

2 HARPS-N Characteristics

2.1 Instrument Overview

HARPS-N (High-Accuracy Radial-velocity Planetary Searcher) is an instrument designed for the measurement of Radial Velocities (RV) at highest accuracy. The HARPS-N Project is collaboration between the Astronomical Observatory of the Geneva University (lead), the Harvard-Smithsonian Center for Astrophysics in Cambridge (USA), the Universities of St. Andrews and Edinburgh, the Queens University of Belfast, and the TNG-INAF Observatory. The project started in 2006, but suffered a two-year delay due to financial problems. After a re-organization of the project in 2010 it was successfully completed in less than two years. In March and April 2012, HARPS-N was installed at the Nasmyth B Focus of the 3.6m TNG, at the Observatory of the Roque de los Muchachos, La Palma Island. The first commissioning took place in April and the first scientific observation started on May 21st.

Its purpose is to reach a long term radial velocity accuracy of 1 m/s for slowly rotating G-dwarfs. Such precision enables the detection of low mass (Saturn like) extra-solar planets and low amplitude stellar oscillations.

The design of HARPS-N is based on the experience acquired with HARPS (installed at 3.6m telescope in La Silla)

The basic design of HARPS-N is therefore very similar to this instrument. The efforts to increase the HARPS-N performance compared to HARPS address mainly three issues:

- Increase of the input beam stability: To send the light from the FEU to the spectrograph we use a 26 m octagonal fiber link. This new geometry increases the light scrambling effect and guarantees a very high precision in radial velocity measurement, since they minimize spectrograph illumination changes due to the positioning error of the star in the fiber entrance.
- Increase the reference precision: Two external high-precision references are included. The first is already available and consists of an ultra-stable Fabry-Perot interferometer. The second one, a stabilized laser-frequency comb, is currently under development and will become available in 2013
- Improvement of the image quality and quantum efficiency: The CCD is a 4Kx4K, back-illuminated e2v CCD231 with 15 μ m square pixels. It is a device processed from standard silicon process and coated with graded AR coating parallel to the readout direction for enhanced response from 385nm to 691nm from left to right.

HARPS-N is a fiber-fed, cross-dispersed echelle spectrograph, based on the design of its predecessor working at ESO 3.6m. This successful spectrograph already has proven its capability to achieve a precision better than 1 meter per second and revealed several super-earth planets in the habitable zone.

Two fibers, an object and a reference fiber of 1 arcsec aperture pick up the light at the Nasmyth B focus of the telescope and feed the spectrograph either with calibration or stellar light. The fiber entrance is re-imaged by the spectrograph optics onto a 4kx4k CCD, where echelle spectra of 69 orders are formed for each fiber. The covered spectral domain ranges from 385nm to 691 nm. The resolution of the spectrograph is given by the fiber diameter and reaches an average value of $R = 115000$.

At this resolution each spectral element is still sampled by 3.3 CCD pixels. The spectrograph is mounted on a nickel plated stainless steel mount and contains no moving parts. Furthermore, in order to avoid spectral drifts due to temperature and air pressure variations, it is accurately controlled in pressure and temperature. In Figure 1 the mechanical mount (on the left) and the installation inside the vacuum vessel (on the right) are shown. A summary of the main HARPS-N characteristics is given in Table 1.

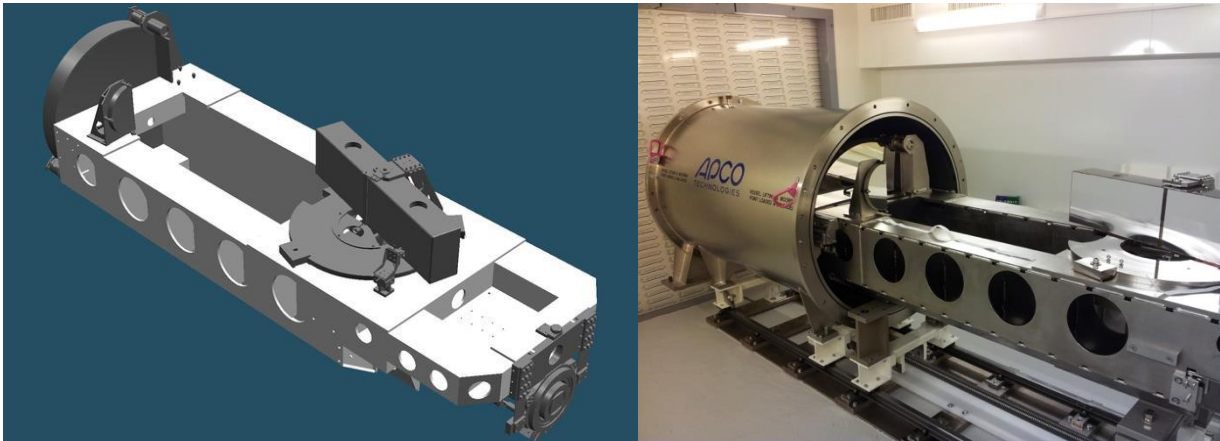

Figure 1 – HARPS-N mechanical design and vacuum vessel

Table 1 - Harps Main Characteristics

Spectrograph type	Fiber fed, cross-dispersed echelle spectrograph
Spectral resolution	$R = 115'000$
Fiber field	FOV = 1"
Wavelength range	385 nm - 691 nm
Total efficiency	$e = 8\%$ @ 550 nm (incl. telescope and atmosphere @ 0.8" seeing)
Sampling	$s = 3.3$ px per FWHM
Calibration	ThAr + Simultaneous reference (feed by 2 fibers)
CCD	Back illuminated CCD 4k4 E2V chips (graded coating)
Pixel size	15 μm
Environment	Vacuum operation - 0.001 K temperature stability
Global short-term precision	0.3 m/s ($10\text{E-}9$)
Global long-term precision	better than 0.6 m/s ($2\text{x}10\text{E-}9$)
Observational efficiency	SNR = 50 per extracted pixel on a $Mv=8$, $T_{\text{Exp}} = 60$ sec
wavelength accuracy	60 m/s ($2\text{x}10\text{E-}7$) on a single line

All necessary moving parts are located in the HARPS-N Front End Unit (FEU), with the exception of the shutter, which is located just outside of the vacuum vessel.

The optical design, shown in Figure 2, is similar to HARPS-S

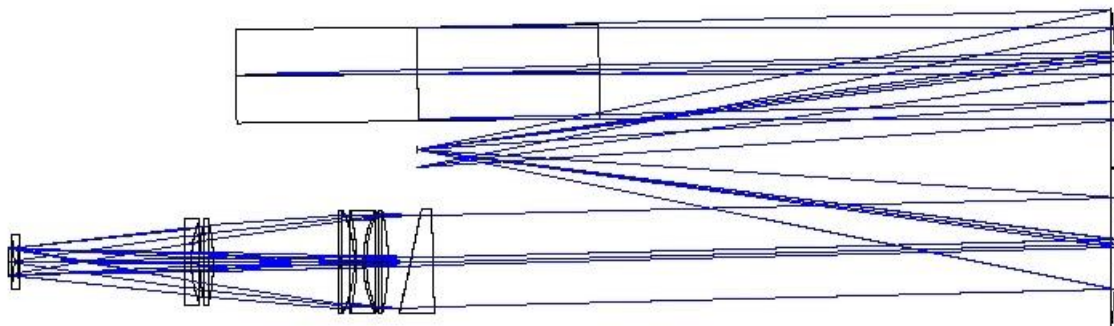

Figure 2 - Optical layout of the spectrograph

Its echelle grating is operated in quasi-Littrow conditions (off plane angle = 0.721 deg blaze angle)

and the collimator in triple pass mode. A white pupil configuration has been adopted with the cross disperser placed at the white pupil. The dioptric camera images the cross-dispersed spectrum on a detector. Two fibres (A and B) feed the spectrograph, one object fibre and one reference fibre (science fibres). The spectra of the light from both fibres are formed by the spectrograph side by side on the detector.

Although all care has been taken to avoid stray light and ghosts, both are present at some level, most noticeably in the blue part of the spectrum. Ghosts seem to be due to third order reflections in the grism (see Table 1 and 2 for some characteristic values). However, the dominant effect is cross-contamination between the two fibers. In the worst case, at (physical) echelle order nr. 92, the contamination is of the level of 1.5% after extraction. In average, however, the cross-contamination between the two fibers is of the order of 0.5%. and in 68 of 70 echelles order lower than 1%.

The instrument is coupled to the telescope through an adapter: the HARPS-N Front End Unit (FEU). Two calibration fibers transmit the light from the calibration unit located in the Nasmyth B Focus and inject it in the two science fibers for calibration.

Table 2 - Halogen lamp (3000k) - Level of diffuse + stray light and ghosts as a percent of the flux in the order

Pipeline order nr.	Echelle order nr.	Wavelength (nm)	Diffused + stray light	Ghosts
68	90	680	0.2%	0.05%
42	116	527	0.4%	0.5%
0	158	390	≈1%	1%

Table 3 - G3V star (5700 K) - Level of diffuse + stray light and ghosts as a percent of the flux in the order

Pipeline order nr.	Echelle order nr.	Wavelength (nm)	Diffused + stray light	Ghosts
68	90	680	0.2%	<0.2%
42	116	527	0.3%	0.2%
0	158	390	<1%	<2%

In the following is presented a brief description of the HARPS-N components: the fibre adapter on the telescope, the calibration unit, and the fibre links connecting these components. A sophisticated online data reduction pipeline is also part of the system (section 8).

2.1.1 Instrument coupling to the telescope

The instrument comprises two parts: the spectrograph which is located in the ground floor of the telescope and the Front End and Calibration unit which it is mounted on the telescope Nasmyth B fork. An optical fiber link sends the light from the Front End Unit to the spectrograph. Figure 3 show the schematic view.

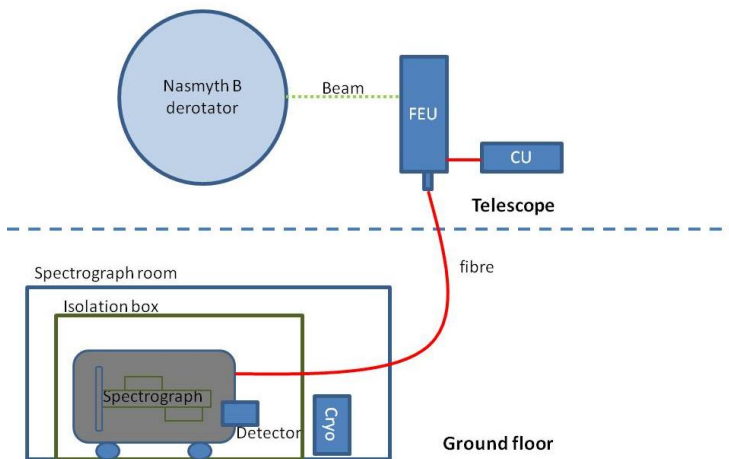

Figure 3 - HARPS-N general schematic view

2.2 Operational overview

The HARPS-N instrument is mounted on the Nasmyth B focus of the TNG telescope in La Palma. It shares the focus with other instruments: Dolores and SARG. The switch between the three instruments requires only the movement of M4 mirror (entrance slider)

2.2.1 Fiber link

To send the light from the FEU to the spectrograph we use a 26 m octagonal fiber link. This new geometry increases the light scrambling effect and guarantees a very high precision in radial velocity measurement, since they minimize spectrograph illumination changes due to the positioning error of the star in the fiber entrance. These fibers have shown excellent laboratory performances, and demonstrated excellent results on sky.

A second fibre link connects the Fabry Perot reference, next to the spectrograph with the HARPS-N Calibration Unit (CU)

2.2.2 Calibration unit (CU)

The calibration unit contains the lamps and the power supply and provides the reference source (thorium, tungsten) for the FEU. Two external high-precision references are included. The first is already available and consists of a Fabry-Perot interferometer. The second one, a stabilized laser-frequency comb, is currently under development and will become available in 2013. The CU is connected via two optical fibres to the FEU which redirects the light of the calibration sources into the spectrograph fibres as required. The two calibration fibres can be fed either by the same or independently by two different calibration sources. Of the two Thorium-Argon lamps, the lamp THAR1 is the absolute reference, and its use should be minimized. Typically it is used for 5 minutes per day during the afternoon calibrations, shining on “fibre A”. The lamp named “THAR2” is used to measure the instrument drift in parallel with the science observations. The lamp can be switch on at any moment. It is particularly useful when one of the other lamps burns out in the course of the night.

The HARPS-N Calibration Unit has two linear mechanisms to move the reference fibers between 5 positions. Three of the positions have lamps, two of which are Thorium-Argon hollow cathode lamps while the other one is a filament halogen lamp. The others two positions are used for ultra-stable external references which can be fed through an optical fiber connection. At the moment one of these positions hosts the Fabry-Perot interferometer, located in the HARPS-N cabinet, close to the spectrograph.

Table 4 - CU components

Movement/component	Description
Thorium lamps 1 and 2	The Thorium Argon lamps are type 4160AHP from S&J Juniper & Co.
Halogen lamp	The halogen lamp is a type 6337 (TBC) Quartz Tungsten Halogen bulb from Newport
Fabry-Perot	The FP interferometer is located close to the spectrograph

2.2.3 Front End Unit (FEU)

The FEU is the first part of the spectrograph where the incoming light from the telescope and from the calibration unit is conditioned and collimated in the fibers. In this stage the incoming beam from the telescope is corrected by the atmosphere dispersion corrector (ADC). The star is maintained in the fiber thanks to the tip-tilt mirror acting together with the autoguider system. The folding mirror selects which object/reference configuration has to be put into the fibers. The optical scheme in Figure 5 shows the optical path inside the FEU and the main components.

Table 5 - FEU components

Movement/component	Description
Calibration fold mirror	linear mechanism with 4 fixed positions
Dust Cover	linear mechanism with two positions (open/close)
Guide camera	FLI PL47-20 (TBC). Connection to the LCU in the control rack is via USB
Guide camera ND filter	Two rotating wheels, with three filters and a transparent glass each, producing attenuation density from 0 to 6 (factor 1 to 1'000'000)
Calibration ND filter	Two rotating wheels with unconstrained motion (can be set to any position in 360 deg). Attenuation range of 1 to 300.
ADC prism	Two atmospheric density compensation prisms with unconstrained motion
Tip-tilt mirror	Precision piezo motor and strain gauge position sensors

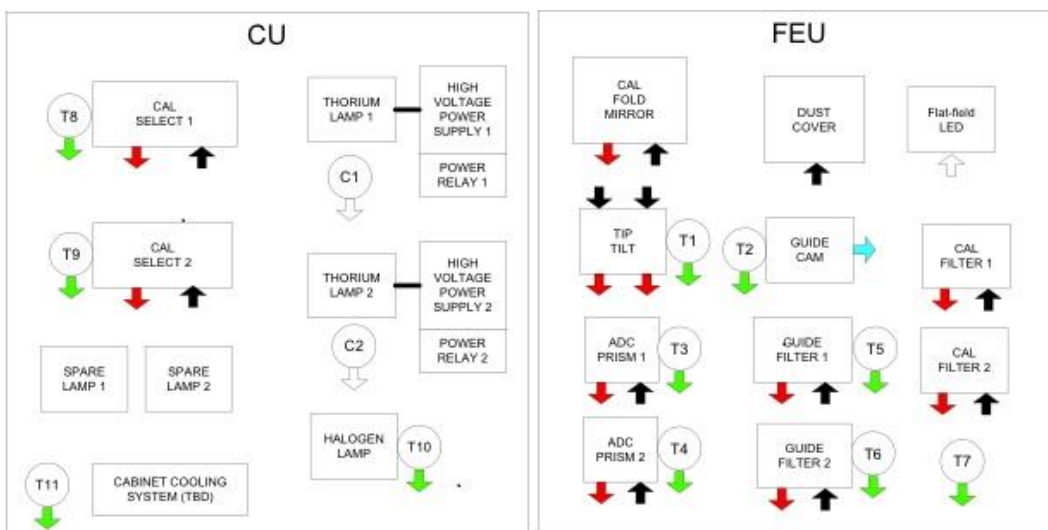

Figure 4 Calibration and Front End Units

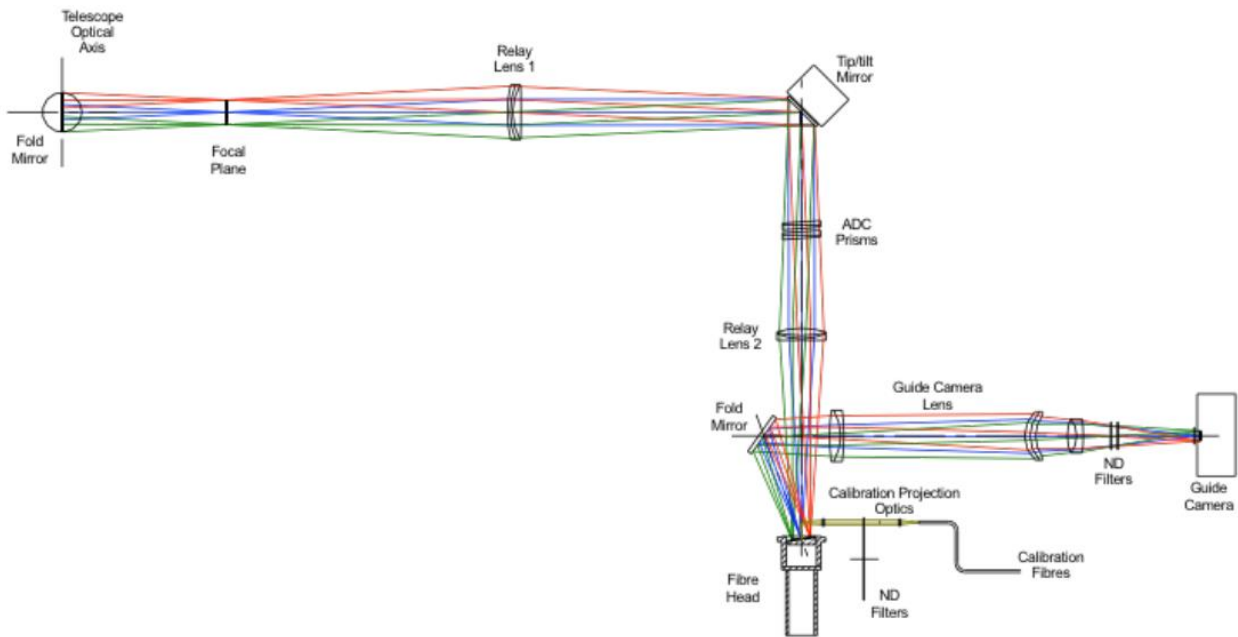

Figure 5 – FEU optical scheme

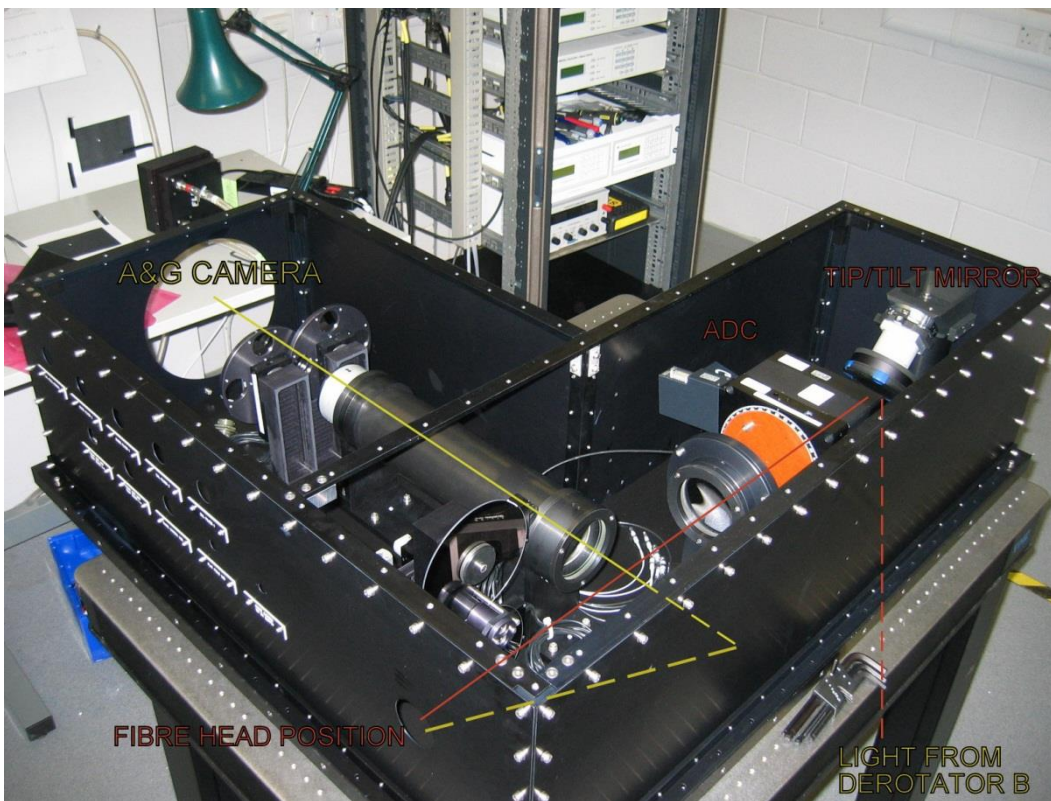

Figure 6 - The Front End Unit

All optical fibres are connected to the FEU which forms the interface to the telescope. The FEU provides several functions:

1. Illumination of the object and the reference fibres; each can be separately fed by the object, the sky, light from a calibration source, or it can be dark.
2. Correction of atmospheric dispersion by means of an ADC.

3. House the technical CCD camera for guiding.
4. Guide the star in the fibre thanks to the tip-tilt mirror acting together with the autoguider system
6. Attenuating the reference light beam from the ThAr lamp via a neutral density wheel to an equivalent exposure time of 20s at zero density. This can be done for exposure times from 20s to 5400s.

2.3 Detector and read out electronics

2.3.1 General detector characteristics

The HARPS-N scientific camera is based on an e2v CCD231 scientific grade CCD detector and an ARC generation III CCD controller. The detector has been integrated in a continuous flow cryostat (CFC) supplied by ESO. The CCD controller allows different readout modes (1, 2 and 4 output readout) and different binnings, but to optimize the automatic data reduction pipeline and the operations we chose only two fixed configurations of the acquisition mode: *The detector is configured without binning and the readout is using two outputs.* The readout speeds is 500 kHz per channel, and the readout noise is < 5e. The electronic conversion factor is about 1.6 e/ADU. The HARPS-N science detector system is summarized in Figure 7.

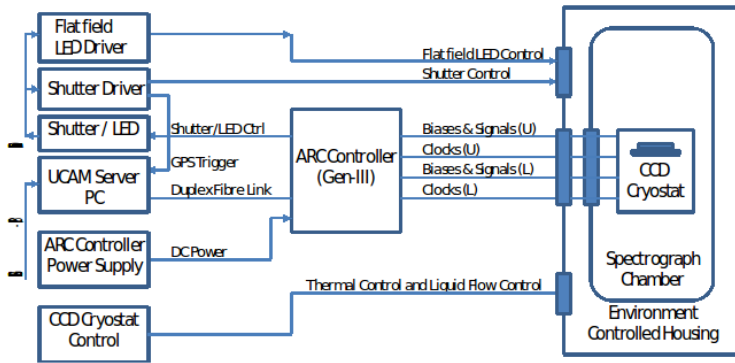

Figure 7 – Detector control system scheme

2.3.2 CCD

The CCD is a 4Kx4K, back-illuminated e2v CCD231 with 15µm square pixels. It is a device processed from standard silicon process and coated with graded AR coating parallel to the readout direction for enhanced response from 385nm to 691nm from left to right as shown in Figure.

The CCD is read by two different amplifiers and a difference of several 100 ADUs in the bias level of the two CCDs might be expected. Following we present the CCD Quantum efficiency curve as provided by the supplier.

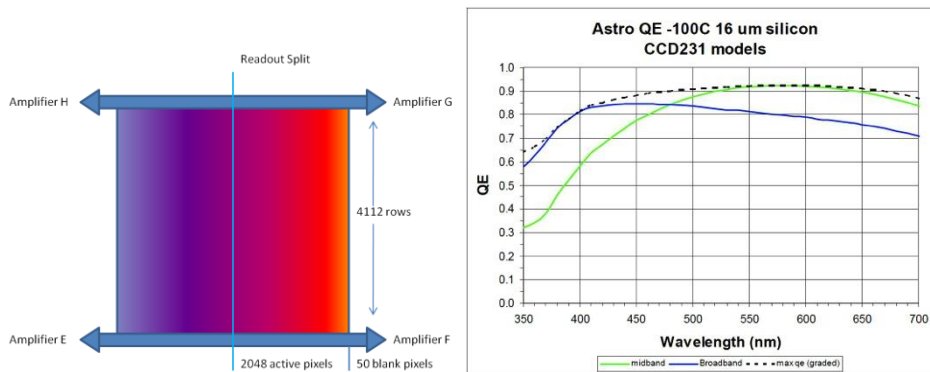

Figure 8 – The CCD coating and quantum efficiency

2.3.3 Cryostat

An ESO supplied continuous liquid nitrogen flow cryostat houses the CCD and a preamplifier board. A dedicated controller regulates the LN flow control to maintain the temperature of the base plate inside the cryostat at a suitable temperature. The CCD mount stage will have a separate temperature control system using a Lakeshore controller to maintain the CCD temperature at its operating value.

2.3.4 CCD controller

The HARPS-N Camera control and data acquisition system (UCam) uses the controller hardware from Astronomy Research Cameras, Inc. USA (ARC Controllers). The ARC controller provides all the bias voltages and clocks required to operate the detector and process the CCD video signal.

2.3.5 Shutter

A 45mm clear aperture bi-stable Uniblitz shutter is mounted just outside the spectrograph vessel to get the timed science exposures. The shutter is controlled by its own controller and is located in the detector electronics rack close to the spectrograph. The control input to the shutter controller is derived from the ARC controller.

2.3.6 Exposure meter

The spectrograph possesses an exposure meter which serves to measure the stellar flux and to accurately measure the mid-time of the exposure (flux weighted mean of the time).

This exposure meter consists of two photomultipliers (one for each of the two fibres entering the spectrograph from the FEU) which use the light picked up at the gap between the two sub-gratings of the echelle mosaic; no light is lost due to this design. The flux in both photomultipliers can be read at the instrument console. It is also recorded in the FITS header (cumulative, average and center of gravity). The expected count rates as a function of stellar magnitude and the estimated errors in RV are given in table(Add the table --- Mv,counts, error-time, RV error). The number of dark counts per second fluctuates between 10 and 15. However, the data-reduction pipeline is currently not using this value to correct for possible departures from the nominal 0.5 value (centered exposure).

The exposure meter GUI shows the status of the two exposure meters, the status of the shutter, some information about the observation and allows the user to change the Mv of the observed star (take care with this option).

The background of the graphic panel turns to darker when the shutter is open.

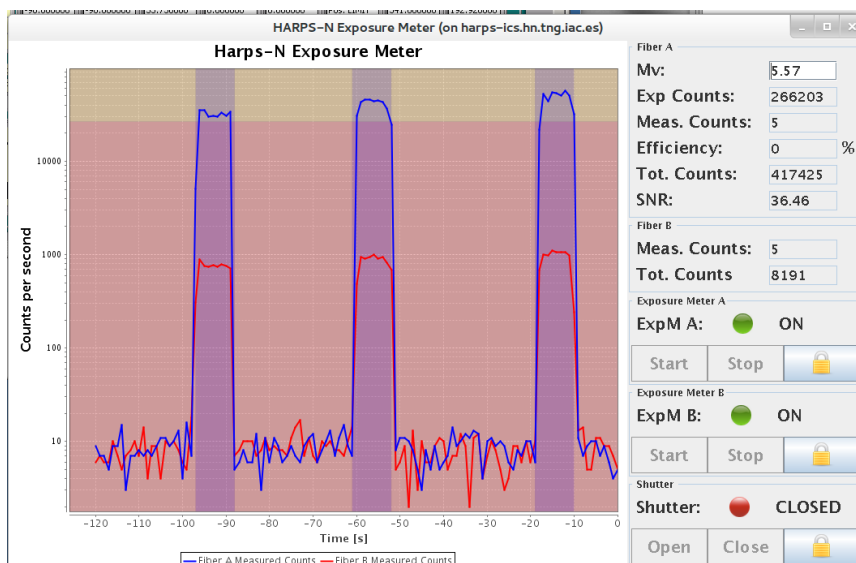

Figure 9 - Exposure meter GUI

2.4 Software architecture

HARPS-N SW is organized in modules, chained together by the Data Flow System. First, the chosen targets are scheduled for observation with the new short-time scheduler (N-STIS), where their parameters are organized in Observation Blocks. The prepared OBs are sent on request to the Observation Control System - the Sequencer. When an OB is get into the OCS, all the instrument subsystems are set up according to its definition: the telescope, the spectrograph and the detector. Once the observation has been executed, the raw image with the FITS keywords gathered from all the subsystems is registered. Then the appropriate data reduction recipe is automatically triggered by the ‘Trigger’ software and the raw data are reduced.

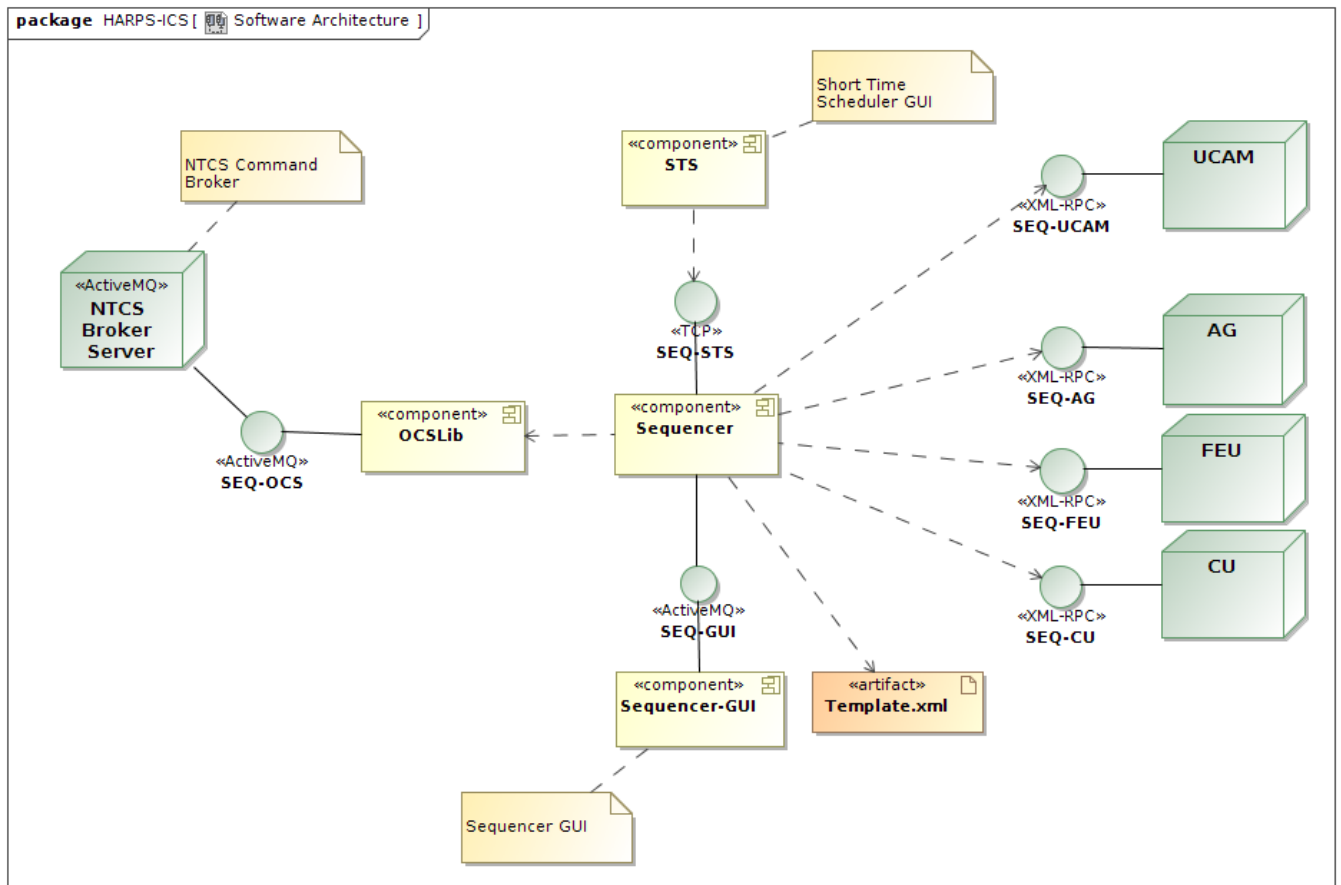

Figure 10 - The HARPS-N software architecture (not upgraded)

2.5 Data acquisition software

The camera control and data acquisition system (UCam) operates under PC control, running RTLinux, interfaced to a Generation-III ARC Controller. The software can be run remotely with a network connection to the host computer. The UCam software runs on three HTTP server processes; Camera Control, File Save and Data De-multiplexer servers. The Camera Control server initializes, configures, downloads and executes applications. The File Save server handles the image data and writes to disk a meta-data file. It also contains instructions to sample and de-multiplex the raw data image. The De-multiplexer server processes the saved data and saves it in FITS file format. A GUI client application is used for controlling the UCam server application.

2.5.1 Short Time Scheduler (STS)

STS is the application which allows the user to prepare the observations. It helps the astronomer to choose and schedule the targets for the observing night, as well as to calibrate the instrument. Within the STS the exposures are organized in blocks, called the Observation Blocks, of three types: science, calibration and technical. Science OBs contain the parameters for the target acquisition, the instrument and the detector

set-up. Calibration OBs describe the calibration exposures. Technical OBs define the instrument initialization and the start and end procedures of the observing night. STS controls the feasibility of the scheduled exposures with respect to the observational conditions and constraints, like the limit airmass, out-of-the-night placement etc. The Exposure Time Calculator, which is part of the STS, helps the user to optimize the exposure time depending on the SNR and vice versa. The STS GUI is shown on Figure 11.

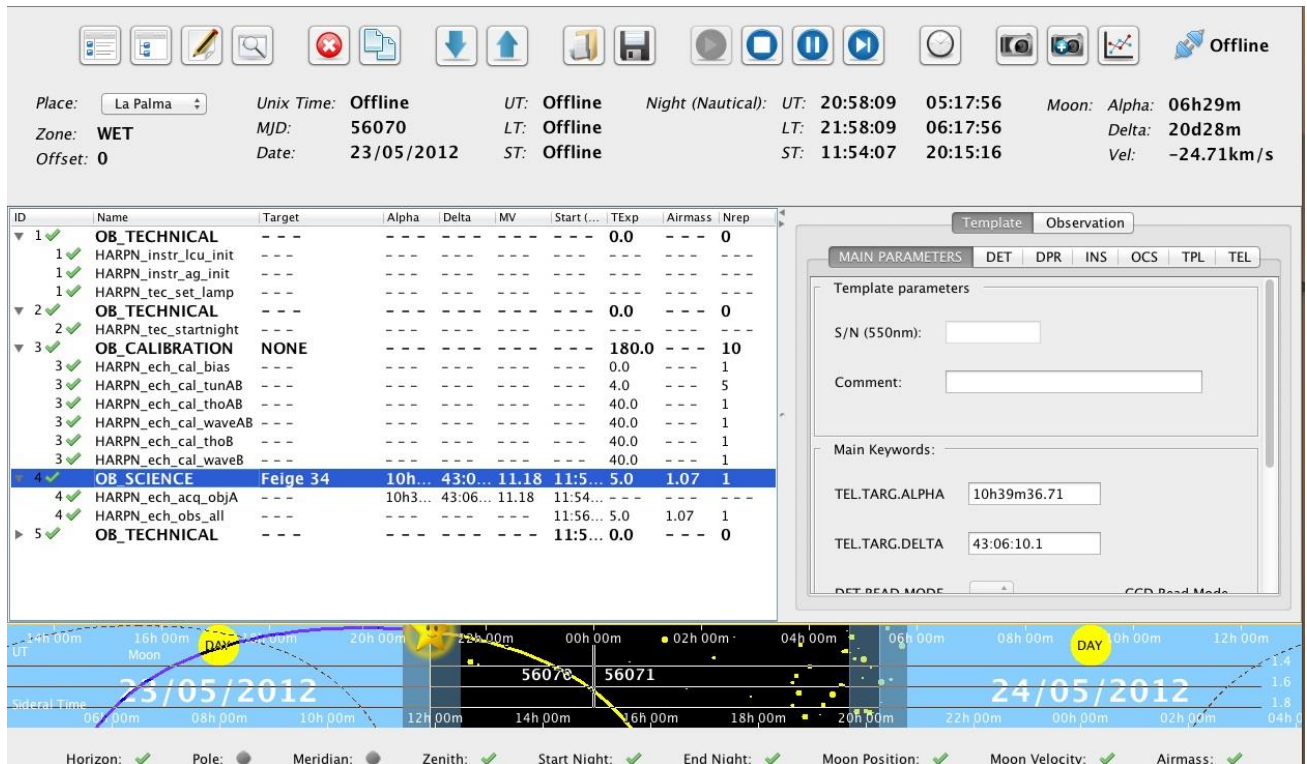

Figure 11 - Short Time Scheduler screenshot

2.5.2 Sequencer

The sequencer is the HARPS-N observation control software. It gets the observation blocks from the STS, and executes them according to several XML template files. Sequencer templates files define the commands, statements and variables to run an Observing Block. Moreover the sequencer is able to emulate HARPS-N units and display, through a GUI, the execution status for each of the commands defined in the command template file (Figure 12). The sequencer interacts with a DS9 application that visualizes the image coming from the Auto guider camera.

2.5.3 Front End Unit, Autoguider and Calibration Unit control (instrument software)

The FEU, CU and AG software are LabView modules which controls the movements and settings of the instrument and the autoguider . This software can also control the units in stand-alone mode as an engineering interface or by the HARPS-N sequencer using an XML-RPC interface.

2.5.4 Telescope Control System

HARPS-N has an interface to the TCS. This interface enables the instrument to send commands to the telescope via the TNG library. Currently HARPS-N is able to send three commands; Pointing, AG offsets and M2 offsets to calculate and correct the focus via an automatic procedure. The connections between both systems are completely asynchronous but when the command finishes successfully the TCS returns an Ok status. When an error condition has arisen, the TCS also returns a message back to the sequencer flagging that condition.

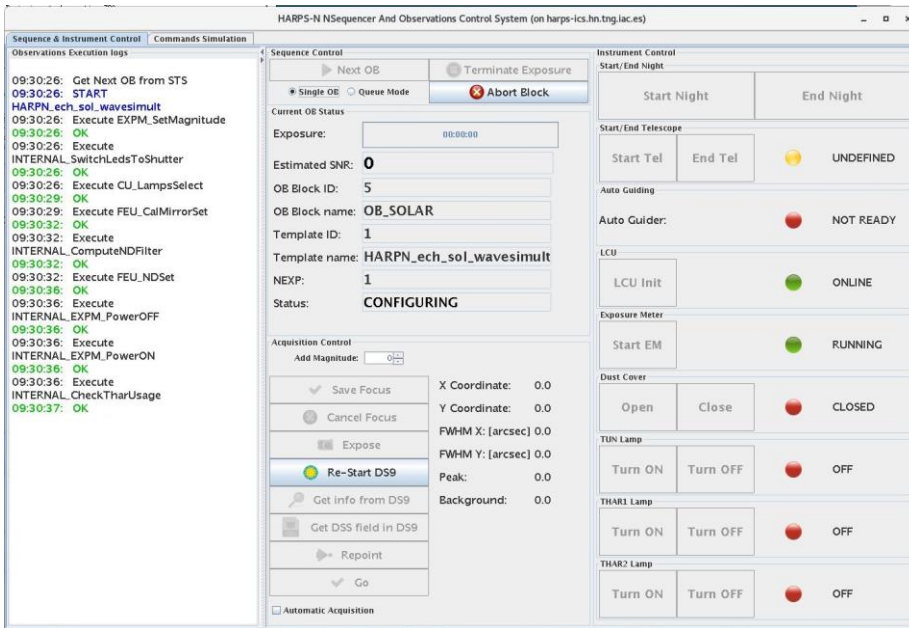

Figure 12 - Sequencer GUI screenshot

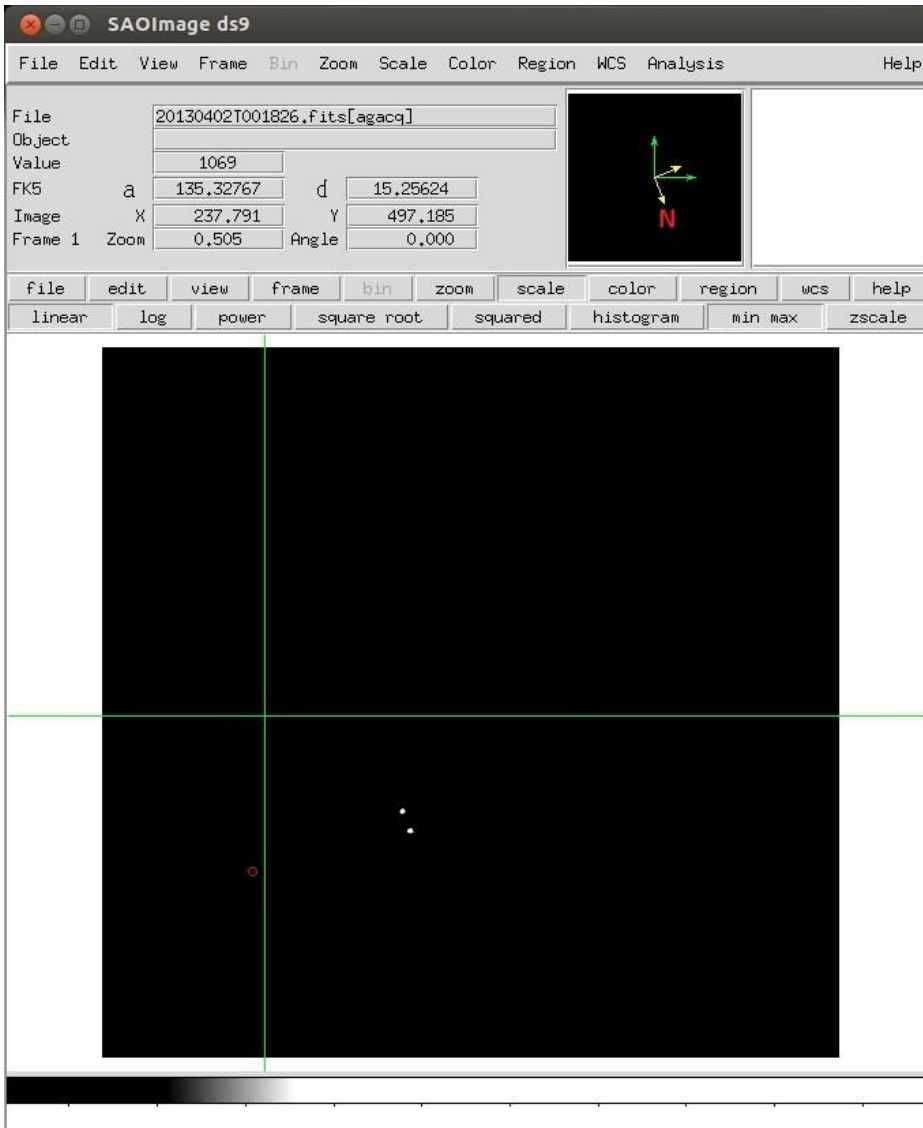

Figure 13 - The Autoguider image visualized by the DS9

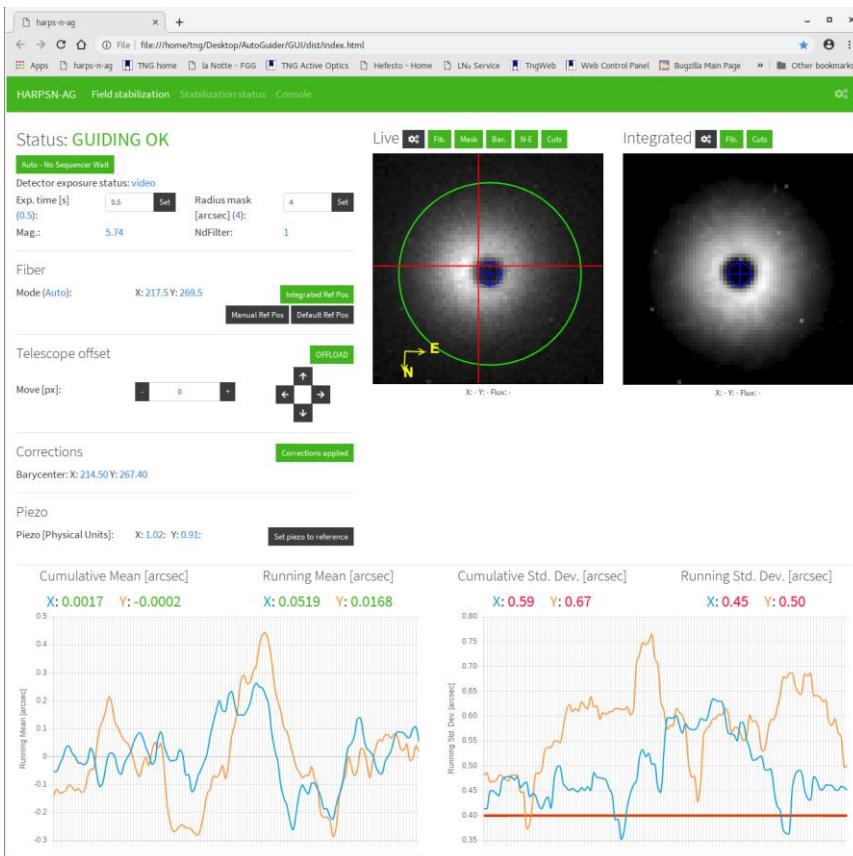

Figure 14 – Autoguiding

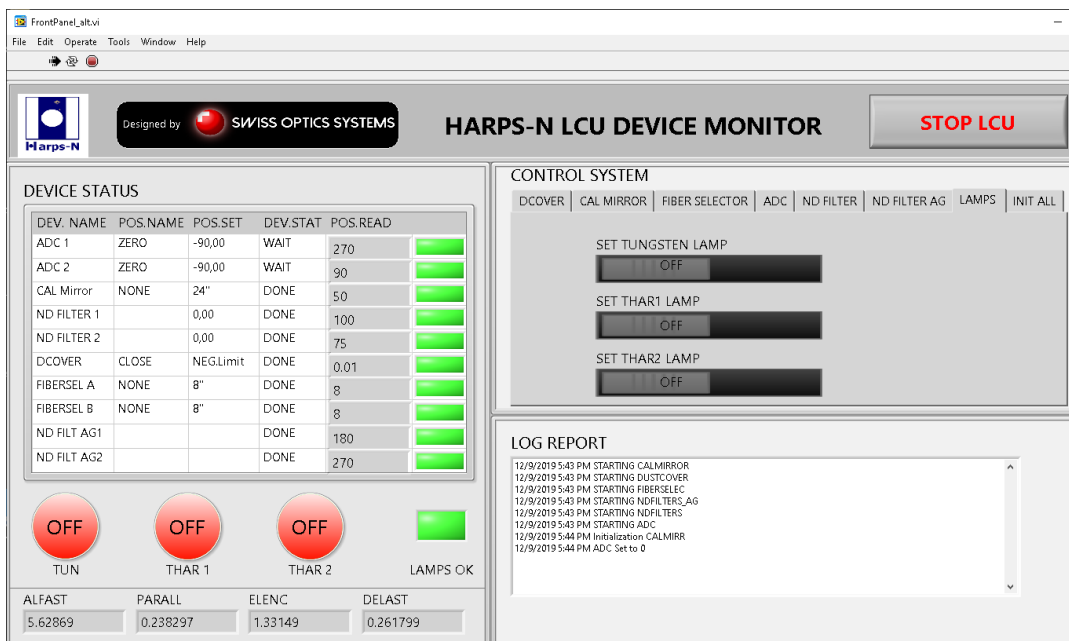

Figure 15 - LCU Device Monitor

2.6 Data Reduction Software

An automatic data reduction system (DRS) is included with HARPS-N to reduce, shortly after the exposure, observations for "classical" spectroscopy and high-precision Doppler measurements with simultaneous wavelength reference.

For science exposures, the DRS outcomes are flat-fielded, wavelength-calibrated spectra and, when

possible and requested, barycentric radial velocity of the target. Calibration exposures are used by the DRS to calibrate the instrument for best-quality scientific reduction. The DRS is designed to run automatically like a batch process on the archived frames. All relevant parameters required by the DRS are passed to the DRS through the FITS headers of the archived frames. Results of the DRS are stored in the FITS keywords of reduced frames.

The top level of the DRS is represented by a set of programs (recipes) performing the various calibration and science tasks. They take as inputs the raw data produced by the instrument and are executed online. Each raw product has its associated DRS recipe which performs the required reduction tasks. An additional top layer application - Trigger - acts as an automatic on-line recipe launcher.

The role of the Data Reduction Software (DRS) is to transform the raw data produced by the instrument into reduced data of scientific quality. These represent the basic products from which the user will start in order to perform the desired specific analysis. Therefore, the endpoint of the DRS processing is defined as the furthest stage at which the data products are still sufficiently generic to be used as inputs for all main HARPS-N science cases.

The main steps of the scientific data reduction are:

- Bias and dark subtraction
- Bad pixels correction
- Background subtraction
- Order extraction with cosmic rejection
- Flat-fielding
- Wavelength calibration
- Merging and rebinning of the spectral orders
- Sky subtraction (if applicable)
- Instrumental drift correction (if applicable)
- Flux calibration Cross-correlation with a numerical template
- Radial velocity computation

For HARPS-N the final products of the DRS process have been found to be the extracted, background-subtracted, cosmic-corrected, flat-fielded and wavelength-calibrated spectra (with and without merging of the spectral orders). The possibility to flux-calibrate the spectra is also available. These products are provided also for the reference fiber (sky or simultaneous wavelength calibration) if applicable. In addition to these reduction products, cross-correlation functions of the spectra are also computed to provide high-precision radial velocities.

One important feature of the DRS environment is the calibration database, in which all calibration products needed to reduce science data are stored. The complete calibration database can be accessed at any time by the DRS recipes, which always choose the best available calibration dataset.

From 2012 to 2021 the operative DRS was the DRS-32 (Original DRS, Figure 16) but, from 28th of October 2021 the ESPRESSO DRS (Figure 17) was added at the HARPS-N reduction system to operate simultaneously in the data reduction of the calibration and scientific frames. Today, and for a limited period of time, the two DRS will be executed at the same time. More information about the two DRS and the way of use can be found in the HARPS-N DRS User Manual [RD10].

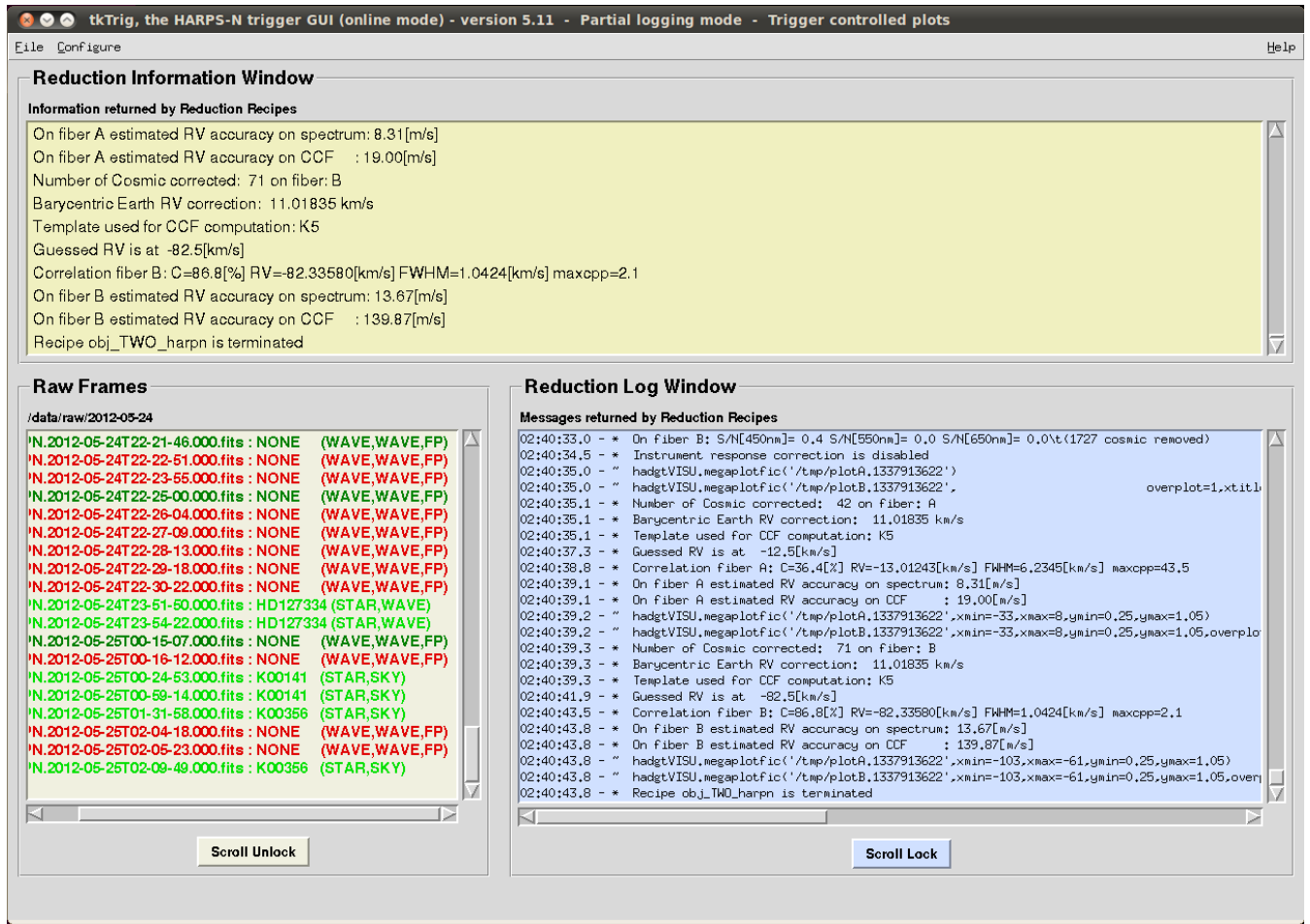

Figure 16 – Screenshot of the data-reduction trigger of the DRS-32 (original DRS)



Figure 17 - Screenshot of the data reduction GUI of the ESPRESSO DRS

2.7 HARPS-N performances

2.7.1 Spectral format and resolution

The recorded spectral format corresponds well to the calculated values (Table 6) gives the order number, central wavelength and the total spectral range covered by the respective echelle order at the top, center, and bottom of the CCD. All the orders up to #158 could be localized and extracted using a tungsten flat-field lamp, while the wavelength calibration was done using the ThAr spectral lamp, Figure 18 shows a part of the corresponding extracted and wavelength calibrated spectrum.

Table 6 - Central wavelength and spectral range of the echelle orders

Pipeline order nr.	Echelle order nr.	Central wavelength [\AA]	Total spectral range $\Delta\lambda$ [\AA]
69	89	6880.8	75.9
68	90	6804.4	75.1
67	91	6729.7	74.3
2	156	3951.6	43.4
1	157	3926.3	43.1
0	158	3901.3	42.8

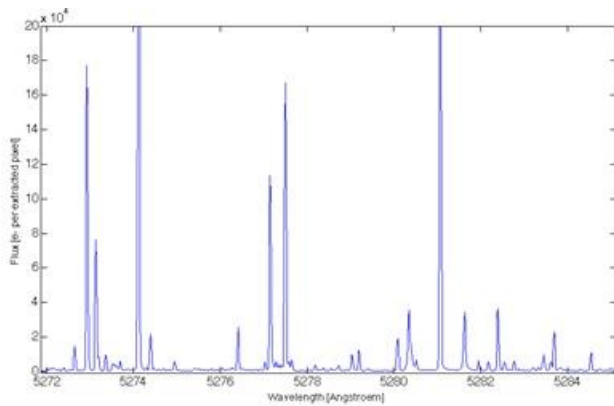

Figure 18 - Portion of the extracted ThAr spectrum order

The image quality, and thus the spectral resolution, varies only slightly in the cross-dispersion direction (see **Error! Reference source not found.** Table 7). The variation is below 10% across the whole CCD. In main dispersion direction we encounter a larger spread in image quality of the order of 20%-30% increasing toward the red side of the echelle order due to expected anamorphism. This effect is however mostly compensated by the echelle-grating dispersion, which increases by about the same amount from the blue to the red side of the echelle order.

Table 7 Image quality of the spectrograph. The FWHM of a spectral line expressed in pixels is indicated for different positions on the scientific CCD.

		Y = 0	Y = 2000	Y = 4000
X = 0	Dispersion	3.7	3.1	2.9
	Cross-dispersion	3.8	3.1	3.2
X = 2000	Dispersion	4.0	3.1	2.8
	Cross-dispersion	4.0	3.1	3.5

X = 4000	Dispersion	3.7	3.0	2.8
	Cross-dispersion	3.6	3.0	3.3

The measured optical parameters are listed in Table 8. These have been determined by means of ThAr calibration exposures. The performances are all compliant with the specifications. The image quality could not be measured directly, thus we give here only an upper limit estimated from the FWHM values for the spectral lines given in Table 7. In order to compute the spectral resolution one has to multiply these values by the pixel size expressed in wavelength. At 530 nm for example, in the center of the CCD, the scale is 0.001415 nm/pixel, and the spectral resolution taking into account the measured spotsize is computed to about $R = 124'000$. Because of the changing dispersion and image quality along the orders the spectral resolution is not perfectly constant. Nowhere on the CCD the spectral resolution decreases below $R = 100'000$, however.

Table 8 - Measured spectrograph parameters

Wavelength range on the CCD	390.1 – 691.5 nm
Spectral resolution at center	115'000
Order width (FWHM) at center	3.2 pixels
Sampling at CCD center	0.0014 nm/pixel
Separation of fibers	16.8 pixels

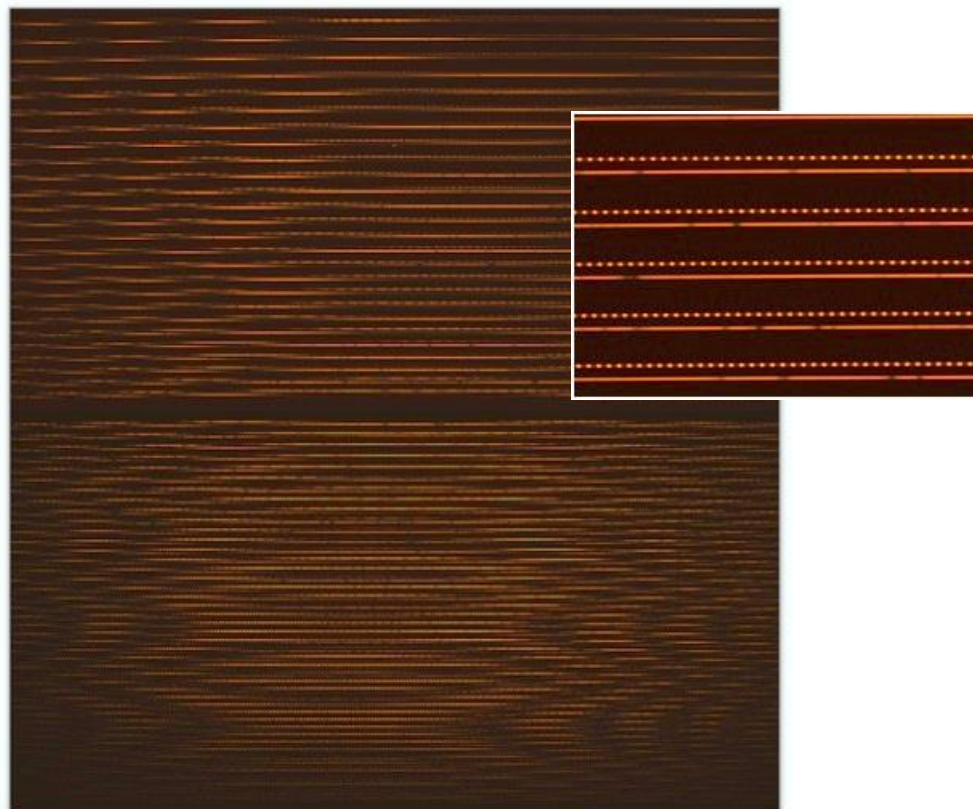

Figure 19 - Raw of a spectrum recorded by HARPS in the 'wave' mode. Two spectra can be distinguished, each one corresponding to one spectrograph fiber illuminated by A) the star (lower fiber) and B) the simultaneous FP (upper fiber).

2.7.2 Efficiency of the spectrograph

The total *calculated* HARPS-N efficiency obtained at the center of the echelle order (blaze condition) is shown in Figure 20. The efficiency of various subsystems is also shown in the figure. The instrument efficiency has been computed using the efficiency data for each single optical component measured in the

laboratory. The shape of the instrument efficiency follows the blaze response of the cross-disperser grism, the rapid cut-off below 380 nm is however accentuated by the band-pass filter which has been installed in order to prevent the second grism-order below 360 nm to be imaged on the CCD. For the CCD we indicate the QE-values measured in laboratory by E2V. Telescope and atmosphere efficiency have been estimated from experience values. The slit efficiency indicates an average value computed at an airmass $Z = 1.03$ and for an ‘effective’ seeing of 0.9 arcsec. In practice we estimate that 0.4 arcsec must be added quadratically to the seeing value to account for additional telescope effects due to image quality and possible defocus.

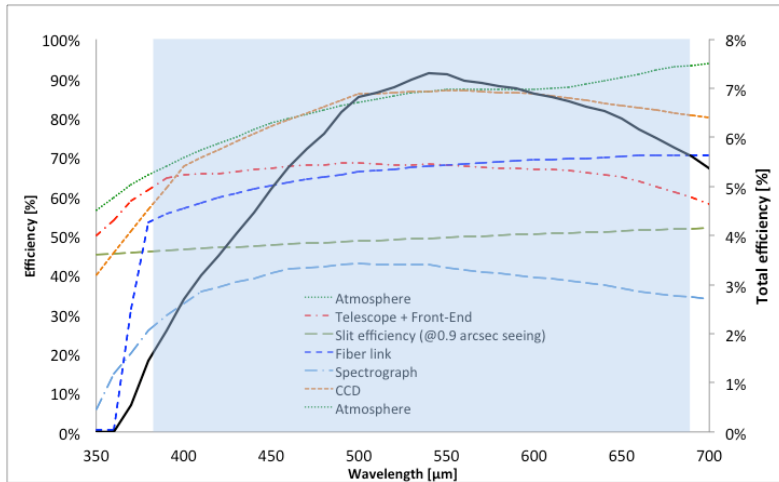

Figure 20 - Total efficiency of HARPS-N (black plain curve, right-hand scale), and efficiency of subsystems (left-hand scale). The values have been calculated for each echelle order at its blaze wavelength. The fast drop below 380 nm is produced by a band-pass filter installed in the fiber-link to remove 2nd-order of the grism. The grey area shows HARPS-N² spectral range.

An interesting aspect is to measure the on-sky performances and derive the instrument efficiency. It is however almost impossible to calculate precisely the effective efficiency of the instrument by observing standard stars, since the sky conditions, telescope focus, etc. are not known with sufficient accuracy. Therefore we prefer just to compare real measurements with calculated count rates. This procedure allows us to identify possible discrepancy without focusing on the detailed efficiency curve, which depends on too many observational parameters. Figure 21 shows the measured SNR as a function of wavelength obtained during one of the first GTO nights on May 24th, 2012. The used star was HD127334, a G5V star with $m_v = 6.36$. The exposure time was of $T_{exp} = 120$ sec and the observation were taken at an airmass of 1.03 and with a seeing of about 0.9 arcsec.

The best measurement of this night is shown, since one has to be sure that efficiency losses due to effects not considered in the exposure-time calculator ETC (e.g. varying atmospheric extinction or telescope defocus) are minimized. The calculated curve was derived for a seeing of 1 arcsec, which actually has been chosen to take into account for the 0.4 arcsec image-quality losses discussed above.

The measured signal-to-noise-ratio SNR is in excellent agreement with the calculated curve. The curve may slightly differ mainly because a) a K0 spectrum was used for the computation and b) the theoretical values of some sub-components may be affected by small errors. On the other hand, and as mentioned above, other aspects such as seeing variations, extinction, image quality etc. cannot be controlled in detail. We conclude therefore that at a level of about 20% precision the expected efficiency matches the actual efficiency of the instrument.

The radial velocity precision obtained on a given star depends on many factors, not the least being the stellar intrinsic noise or jitter. Nevertheless, even for a ‘quiet’ star, the obtained precision depends on the spectral line width, depths, and density, which all depend partially on the spectral type. In order to provide a bench mark for the transformation between SNR and expected radial-velocity precision, we focus on a quiet, non-rotating K0 dwarf. In this case, a SNR per extracted pixel of about 50 is obtained on a star with

$m_v = 8$ in 60 s. At this SNR value a radial-velocity (photon-noise-limited) precision of the order of 1.3 m/s can be expected.

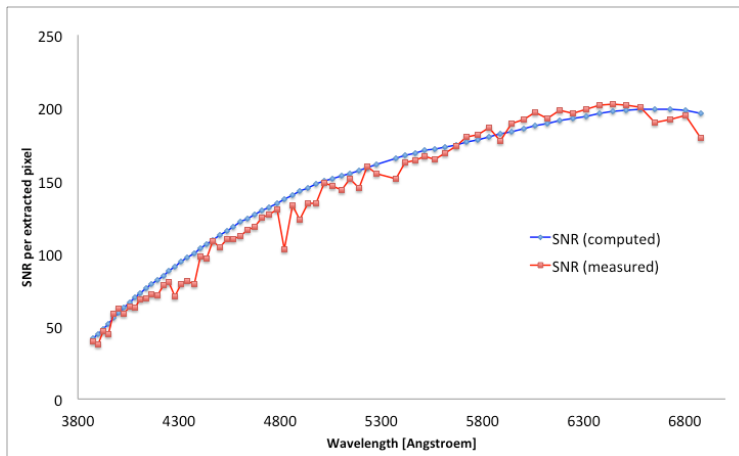

Figure 21 - Measured signal-to-noise ratio SNR of HARPS-N (red curve) compared with the values computed by the exposure-time calculator of the STS (blue curve). The efficiency tests have been carried out on HD 127334, a $m_v = 6.36$ G5 star. The exposure time was of 120 seconds.

2.7.3 Instrumental stability and simultaneous reference

When observing in ‘wave’ mode, it is possible to feed fiber A with a ThAr spectrum and fiber B with the FP spectrum. By doing so, it is possible to a) track possible instrumental drifts and b) estimate the power of the ‘simultaneous reference’ technique. This technique is employed in HARPS-N to remove possible instrumental drifts from the stellar radial velocity: While calibrating the instrument or observing the star, the second spectrograph fiber B is always illuminated by a spectral reference source, in this case a Fabry-Pérot (FP) etalon illuminated in white light. The stable FP records potential drifts of the instrument occurred between calibration and observation. Once expressed in terms of radial-velocity, the recorded value can be subtracted from the measured stellar radial velocity to correct for these drifts.

We have done laboratory tests to measure the performances of the simultaneous reference technique. An example is shown in Figure 22, which shows the ‘radial velocity’ of the ThAr (fiber A) and FP (fiber B) spectral sources as a function of exposure number. Since one exposure was taken every minute, the series represents a time span of about 5 hours. During this time, we have made a ‘stress test’ of the instrument by pumping on the vacuum chamber and by changing the temperature of the detector dewar, both producing ‘absolute’ radial-velocity changes of several meters-per-second.

The obtained results are very satisfactory: During the first hour, during which the instrument was not touched, the radial velocity remains stable well within the 1 m/s level. It must be noted that this means that the spectrum did not move, in absolute terms, by more than 0.001 pixels or 15 nm on the scientific CCD. This is actually the typical stability obtained with HARPS-N during a night, despite the fact that the thermal control system of HARPS-N has not yet been fully implemented. The dispersion on the drift measurements over this same 1-hour period is of the order of 30 cm/s. This “noise” has a typical period of 10 minutes. It is observed also on HARPS-N (south) and it is possibly due to tiny, but periodic temperature variations of the CCD or its dewar. It is important to note, however, that on the differential value one obtains a dispersion of 8 cm/s, which is almost identical with the combined photon-noise precision of the ThAr and FP spectral sources. This demonstrates without any doubt that the simultaneous reference technique is able to correct for drifts at the level of 10 cm/s and below.

This statement is strengthened by the fact that, over the whole test duration, the differential drift never exceeded the 40 cm/s level, despite the fact that the instrument had been exposed to extreme stress-conditions never occurring during standard operations. Furthermore, the differential drift appears to be

compatible with zero after 5 hours, which not only confirms the power of the used technique but also demonstrates that our FP-based reference source is stable within 10 cm/s during an observation night.

However, the FP does not yet provide the full stability on longer time scales, e.g. from day to day, probably because of a thermal instability of the temperature regulation. As long as this problem has not been solved, we recommend to observe in the standard simultaneous thorium mode or without simultaneous reference, in case of faint objects with $m_v > 12$.

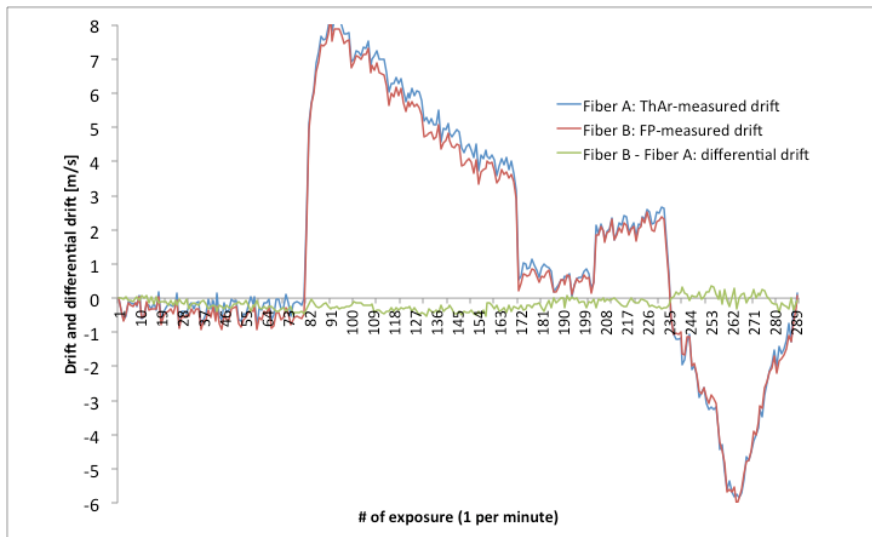

Figure 22 -Short-term stability of the spectrograph and quality of the FP and ThAr tracking technique

2.7.4 On-sky precision

HARPS-N makes use of octagonal optical fibers and a double scrambler, which, when combined, are supposed to perfectly scramble the light illuminating the spectrograph and thus remove any potential guiding effect on the measured radial velocity. On HARPS-N (south), an effect of the order of 3 to 4 m/s was measured when moving the star from the center of the fiber to the edge. This effect was observed to be symmetric with respect to the fiber center and fully understood as a consequence of differential pupil illumination of the spectrograph due to non-perfect scrambling by circular fibers.

This experience led us to use octagonal fibers for HARPS-N. Tests in the laboratory had already shown that we could expect an excellent performance, but tests on the sky and using a ‘real’ star had to be performed. Summarizes the results of this test: During a night with good atmospheric seeing conditions (always below 1 arcsec) we have measured the radial-velocity of the star HD 89269. During this sequence we have alternatively centered and de-centered the star at the entrance of the optical fiber. The de-centering was of 0.5 arcsec, which means that the star was placed on the edge of the fiber, in the identical way we had done this on HARPS-N (south) in 2003. The first remarkable aspect is that the p-modes of the star (pulsation) of about 2 m/s semi-amplitude are directly visible in the temporal series. The second aspect concerns the excellent scrambling, and is represented by the fact that no discontinuity is observed in the radial velocities when switching from centered to de-centered observations. In order to estimate the off-guiding effect on the radial velocity we have averaged all centered exposures and compared them to all de-centered exposures. The difference in radial velocity is of the order of 0.5 m/s, which is in turn small compared to results obtained on HARPS-N (south). We consider this value to be actually an upper limit of the effect, since the measurement ‘noise’ is dominated by the stellar pulsation. This result is thus fully consistent with the laboratory measurement, which had indicated an improvement of about a factor 10 on the scrambling efficiency of octagonal fibers compared to circular fibers.

At the moment of writing no long-term radial-velocity performances can be reported, given the fact that HARPS-N was installed in April 2012 and that the first GTO run took place from May 21st to 25th, 2012. The radial-velocity dispersion over 2.5 hours and 41 exposures is of only 1.08 m/s; most probably this is

completely dominated by the stellar p-modes. The same star was observed, although at much lower frequency, during all the four half nights of the first GTO run. The obtained dispersion is of the order of 1.5 m/s. We are convinced that this value will be improved further by optimizing the instrument and the data-reduction software. We expect that a long-term instrumental precision of the about 0.5 m/s can and will be attained after the first semester of operations.

3 Observing modes

HARPS-N offers the following observing modes:

- Simultaneous Thorium Reference observation
- Simultaneous Fabry Perot Reference observation
- Classical fibre spectroscopy (with and without sky)

3.1 Simultaneous Thorium reference method

The Simultaneous Thorium Reference mode is the base-line observation mode to get the best short term accuracy in radial velocity determination from the instrument. In this mode fibre B is fed by the Thorium lamp while fibre A is on the stellar target.

A variable neutral density (ND) filter is used to keep the Thorium spectrum at a flux level equivalent to a 40 seconds exposure with zero density. Since the density to which the ND filter is set is computed by the instrument software from the exposure time as defined in the template.

The Thorium spectrum which is recorded simultaneously with the stellar spectrum is used to compute the instrument drift from the last wavelength calibration, usually done at the beginning of the night.

The calibration unit contains two identical ThAr lamps. For the simultaneous reference method only the lamp “THAR2” can be used. The lamp “THAR1” should be used as a reference only for the afternoon calibrations and switch off afterwards. Ideally this should prolong the life time of this reference lamp.

3.1.1 Performance

For estimates of the SNR in the HARPS-N mode under given observing conditions the Exposure Time Calculator (ETC), included in the New Short Term Scheduler (NSTS), available via the HARPS-N web page <http://obswww.unige.ch/~buchschn/> can be used with an accuracy of about 10%. The relationship between photon noise induced radial velocity error and S/N is given by the following formula:

$$rms(m/s) \approx \frac{100}{S/N_{550nm}}$$

As a rule of thumb, an photon noise error of 1.3 m/s (or S/N = 50) can be achieved for a 8th magnitude K0-dwarf in 60 seconds in the HARPS-N mode. Note, that due to the small fiber aperture on the sky (1”), the performances assume a seeing better than 1” and critically depend on seeing.

3.1.2 Calibrations

The Simultaneous Thorium Reference Method needs a sequence of calibration exposures to be taken before the beginning of the night. No further calibration exposures are required during the night.

In order to produce the correct calibration sequence the available observing block “RV Standard Calibration” should be executed without changes before the beginning of the night. It includes:

- 2 bias exposure. The CCD bias is very stable; only one bias is therefore needed by the pipeline.

Template: HARPN_ech_cal_bias

- 2 Tungsten lamp exposures where respectively fibre A and fibre B are successively fed by the Tungsten lamp. These exposures are used for order location which is done automatically by the pipeline. The processed products are stored in the calibration database if they pass the quality control of the pipeline, and used for the subsequent reduction of the scientific exposures of the

following night.

Template: HARPN_ech_cal_tun

- A sequence of 5 Tungsten lamp exposures (defined by NREP=5) where both fibres are simultaneously illuminated.
This sequence is used by the data reduction pipeline for producing a spectral “master flat-field” which will be stored in the local calibration data base if it passes the quality control by the pipeline, and used for the subsequent reduction of the scientific exposures of the following night.

Template: HARPN_ech_cal_tunAB

- 2 (for reasons of redundancy) Thorium exposures in which both fibres are simultaneously fed by light from the Thorium-Argon lamps.
The THAR1, long term reference lamp, illuminates fibre A, the THAR2 lamp inlluminates fibre B. During the night only the THAR2 lamp will be used as the reference. The ON time of the THAR1 lamp is minimized in order to keep it as an absolute reference along the years. Each exposure is used to build a wavelength solution. The instrumental drift with respect to the previous calibration frames is measured (expressed in m/s). If accepted by the built-in quality control, the wavelength solution is stored in the local calibration data base and used for the subsequent reduction of the scientific exposures of the following night.

Template: HARPN_ech_cal_thoAB

- 2 (for reasons of redundancy) Fabry Perot exposures in which both fibres are simultaneously fed by light from the Fabry Perot interferometer.
The Fabry Perot interferometer, illuminates fibre A and fibre B. The instrumental drift with respect to the previous calibration frames is measured (expressed in m/s). If accepted by the built-in quality control, the wavelength solution is stored in the local calibration data base and used for the subsequent reduction of the scientific exposures of the following night.

Template: HARPN_ech_cal_waveAB

- 1 Thorium exposures in which fibres B is fed by light from the ThAr2 lamp.

Template: HARPN_ech_cal_thob

- 1 Fabry-perot exposures in which fibres B is fed by light from the Fabry Perot reference.

Template: HARPN_ech_cal_waveB

The user may then repeat a sequence of flat-fields with more than 5 exposures if a SNR higher than 300 is aimed at in later science exposures. The “RV Standard Calibration” acquires 5 flat exposures and reaches a Signal to Noise Ratio (SNR) of about SNR=400 at 450nm, 500 at 550nm and SNR=900 at 650nm.

In case the “RV Standard Calibration” is not taken, the DRS will use the youngest available calibration data. This might introduce offsets, and possibly have a negative effect on the achievable precision.

The pipeline performs quality checks on each frame. In case one of the frames does not pass the quality check, the youngest available calibration data will be used. In this case is however advisable to contact the support astronomer on site, in order to make sure the general health of the instrument is not compromised.

3.1.3 Observations

The necessary acquisition and observing templates are available:

- **HARPN_ech_acq_thosimult** for star acquisition and setup of simultaneous Th exposures
- **HARPN_ech_obs_all** for taking spectroscopy exposures

For a detailed description of the templates see section **Error! Reference source not found.** and the HARPS-N Template Reference Guide.

3.1.4 Pipeline, data reduction

The online pipeline does spectrum extraction, wavelength calibration, RV calculation using a template spectrum of (ideally) the same spectral type as the target star. A comprehensive library of stellar spectral templates is being built up. Currently it contains templates of the following spectral type (others are in preparation): templates

G2
K5
M2

The pipeline applies the following corrections: detector bias, dark, flatfield, cosmic ray removal, and rebins the spectrum according to the wavelength calibration obtained in the afternoon or in the closest successful HARPS-N ech cal thoAB exposures. The drift correction is not done. At present the drift is measured and inserted in the fits header, but is not applied to the RV value. The user can do that if he/she wishes, by simple subtraction. Radial velocity and Julian date correction are calculated in the solar system barycenter reference (based on the Bretagnon & Francou 1988 VSOP87E planetary theory). Radial velocity computation is automatically done for all exposure types when a radial velocity value is provided by the TARG RV parameter. The RV must be provided with an accuracy better than 1-2 km/s. For more details about the pipeline (Data Reduction Software, DRS) please, refer to the DRS user manual. For pipeline execution times see section 5.4.1.

3.2 Simultaneous Fabry Perot reference method

The Simultaneous Fabry-Perot mode is the base-line observation mode to get the best short term accuracy in radial velocity determination from the instrument. In this mode fibre B is fed by the Fabry-Perot while fibre A is on the stellar target.

A variable neutral density (ND) filter is used to keep the Fabry-Perot spectrum at a flux level equivalent to a 40 seconds exposure with zero density. Since the density to which the ND filter is set is computed by the instrument software from the exposure time as defined in the template.

The Fabry-Perot spectrum which is recorded simultaneously with the stellar spectrum is used to compute the instrument drift from the last wavelength calibration, usually done at the beginning of the night.

The calibration unit contains two identical Fabry-Perot spectra. For the simultaneous reference method the Fabry-Perot in fiber B is used.

3.2.1 Performance

For estimates of the SNR with an accuracy of about 10% under given observing conditions the ETC available via the HARPS-N web pages (<http://obswww.unige.ch/~buchschn/>) can be used (see section **Error! Reference source not found.**).

3.2.2 Calibrations

A calibration sequence similar to the Simultaneous Thorium Reference method is recommended before the beginning of the night.

3.2.3 Observations

The necessary acquisition and observing templates are available:

- **HARPN_ech_acq_wavesimult** for star acquisition and setup of simultaneous fabry perot exposures
- **HARPN_ech__obs_all** for taking spectroscopy exposures

For a detailed description of the templates see section **Error! Reference source not found.** and the HARPS-N Template Reference Guide.

3.2.4 Pipeline, data reduction

The pipeline performs the same reduction as for the simultaneous Thorium reference method (section 3.1.4) but it does not correct for the instrumental drift (this one not being traced by the Thorium lamp as in the simultaneous Thorium reference method). It does not perform sky subtraction. For more details about the pipeline (Data Reduction Software, DRS) please, refer to the DRS user manual.

3.3 Classical fibre spectroscopy

Classical fibre spectroscopy can be done in two different ways, depending on the target and the goal of the program:

1. fibre A on target and DARK on fibre B (objA observation)
2. fibre A on target and fibre B on the sky (objAB observation)

objA observation should be preferred for objects much brighter than the sky/moon background where a careful CCD background correction may be needed. For this type of observation, the pipeline provides only the spectrum of the fibre A and uses fibre B order location to compute the CCD background.

objAB observation should be preferred when a sky-background correction may be needed. The data reduction pipeline provides an extracted spectrum for each fibre. The sky correction is left to the user.

The high stability of the instrument makes wavelength drifts very small. If the same calibration sequence than for the simultaneous Thorium reference method is run before the beginning of the night, a RV accuracy generally better than 3 m/s along the whole night can be expected.

3.3.1 Performance

For estimates of the SNR with an accuracy of about 10% under given observing conditions the ETC available via the HARPS-N web pages <http://obswww.unige.ch/~buchschn/>) can be used (see section **Error! Reference source not found.**).

3.3.2 Calibrations

A calibration sequence similar to the Simultaneous Thorium Reference method is recommended before the beginning of the night.

3.3.3 Observations

The necessary acquisition and observing templates are available:

- **HARPN_ech_acq_objA** acquisition and setup for fibre spectroscopy with the object in fibre A
- **HARPN_ech_acq__objAB** acquisition and setup for fibre spectroscopy with the object in fibre A and sky in fibre B
- **HARPN_ech_obs_all** for taking spectroscopy exposures

3.3.4 Pipeline, data reduction

The pipeline performs the same reduction as for the simultaneous Thorium reference method (section

3.1.4) but it does not correct for the instrumental drift (this one not being traced by the Thorium lamp as in the simultaneous Thorium reference method). It does not perform sky subtraction. For more details about the pipeline (Data Reduction Software, DRS) please, refer to the DRS user manual.

3.4 Focusing of the telescope

A telescope focusing procedure can be done with the focus template. The template points the selected star, set the spectrograph, executes the focus procedure and move the telescope M2 mirror.

3.4.1 Performance

The focus template reaches the optimum focuses of the telescope if the seeing conditions are stable. The procedure takes 8 minutes to execute. For more details about the focus procedure, Please, refer to the *HARPS-N operation guide* manual.

3.4.2 Template

The necessary focusing template is available:

- **HARPN_focus** focusing of the telescope

3.5 RV Accuracy

The high RV accuracy obtainable with HARPS-N is a result of an extremely stable and strictly controlled instrument and data reduction software designed and optimized for the purpose. The pipeline RV determination is optimized for data taken in the simultaneous Thorium reference method.

The short term RV accuracy of HARPS-N with the simultaneous Thorium reference method has been demonstrated, during the three commissioning phases, to be below 1 m/s.

The RV accuracy can be affected by several factors external to the instrument:

- Photon noise
- Telescope focus
- Centering errors
- Thorium calibration errors

3.5.1 Photon noise

For a G8 star a $RV_{\text{rms,photon}} \approx 1$ m/s due to photon noise only is reached with a S/N ratio of about 67 per pixel (at 550nm). The photon noise introduced in the RV measurement scales with the SNR in the continuum, as long as one stays in the photon-limited (and not detector-limited) domain, i.e. at $SNR > 5$

3.5.2 Telescope focus

Opposite to HARPS@ESO, a defocus of the telescope does not introduce any RV offset thanks to the use of octagonal fibers. Good focus is however extremely important for efficiency reasons.

3.5.3 Centering errors

Opposite to HARPS@ESO, for which a de-centering of $0.5''$ introduces a RV offset of 3 m/s, no such effect has been observed on HARPS-N thanks to the use of octagonal fibers.

3.5.4 Thorium calibration errors

A total instrumental error of about 0.5 m/s must be expected due to the Thorium simultaneous reference and calibration (drift tracking and zero point). The zero point error is by far the dominant source

with a contribution of 0.3 to 0.4 m/s.

4 Preparing the observations

4.1 Introduction

HARPS-N uses the way of observing based on pre-prepared Observing Blocks. This chapter describes the philosophy behind this concept, the available tools and the HARPS-N specific input.

In order to reach the full performance of HARPS-N with respect to the determination of accurate radial velocities, the following items should be noted:

1. to achieve an accurate solar system barycentric Radial velocity, correction of 0.3 m/s, the target coordinates must be known to within $3''$ including proper motion
2. The RV of a star needs to be known to within 1-2 km/s to give the pipeline a reasonable starting point for the RV computation.

4.2 Introducing Observing Blocks

An Observing Block (OB) is a logical unit specifying the telescope, instrument and detector parameters and the actions needed to obtain a “single” observation. It is the smallest “schedulable” entity, which means that the execution of an OB is normally not interrupted as soon as the target has been acquired and centered on the fibre. An OB is executed only once; when identical observation sequences are required (e.g. repeated observations using the same instrument setting, but different target), a series of OBs must be built.

Usually, one OB consists of two separate entities: the acquisition template and the observation template(s). For normal science observations HARPS-N uses four different acquisition templates (different for the various observing modes) and one common observing template.

4.2.1 Observing blocks

There are three different observing blocks defined:

OB_SCIENCE
OB_CALIBRATION
OB_TECHICAL

4.2.2 Science templates

HARPS-N uses the science template to preset the telescope and to set up the instrument configuration for the selected observing mode. The following acquisition templates are available:

HARPS-N_ech_acq_thosimult	for simultaneous Th exposures
HARPN_ech_acq_wavesimult	for simultaneous Fabry-Perot exposures
HARPN_ech_acq_objA	for fibre spectroscopy (no sky)
HARPN_ech_acq_objAB	for fibre spectroscopy (with sky)
HARPN_ech_acq_eff	for fibre spectroscopy (sky in both fibers)

All the acquisition templates require an initial guess of the RV. For optimum RV determination the expected radial velocity of the source should be entered with an accuracy of $\approx 2\text{km/s}$.

The focus template is included in the science OB because the procedure moves the telescope and uses the guiding camera to calculate the optimum focus.

HARPN_focus is used to focusing the telescope

Note: In the focus OB the **HARPN_ech_obs_all** must be removed

A description of the focus procedure is given in the HARPS-N Operation Guide.

A description of the acquisition templates is given in the HARPS-N Template Reference Guide.

4.2.3 Calibration templates

Several calibration templates are available. However, all calibrations necessary for a proper data reduction with the online pipeline are performed by the ready-to-run calibration OB (named “OB Standard Calibration”). The details of this OB are described in section 3.1.2.

Only if additional calibrations are deemed necessary one needs to use one (or more) of the following templates:

HARPN_ech_cal_bias	for taking bias frames
HARPN_ech_cal_dark	for taking dark frames
HARPN_ech_cal_tunA/B	for taking order location frames through fibres A or B
HARPN_ech_cal_tunAB	for taking spectral flat field frames through fibres A and B
HARPN_ech_cal_thoA/B	for taking a wavelength calibration through fibres A or B
HARPN_ech_cal_thoAB	for taking a wavelength calibration through both fibres
HARPN_ech_cal_waveA/B	for taking a wavelength calibration through fibres A or B
HARPN_ech_cal_waveAB	for taking a wavelength calibration through fibres A and B

If the number of exposures is set different from one in the **ech_cal_tunAB** or **ech_cal_thoAB** templates, the pipeline will wait for the last exposure, sum all the exposures and then process the resulting frame. A description of the observation template is given in the HARPS-N Template Guide.

4.2.4 Technical templates

HARPN_instr_lcu_init	for the initialization of the calibration and Front End units
HARPN_instr_ag_init	for the initialization of the auto-guider
HARPN_tec_set_lamp	to set the power of the lamps
HARPN_tec_startnight	to set the instrument for observation
HARPN_tec_endnight	to set the instrument in rest position

4.2.5 New Short Time Scheduler (NSTS)

NSTS is the standard tool for the building of observing blocks from the instrument specific templates. A comprehensive description including the user manual is available from the Geneva University web pages at: <http://obswww.unige.ch/~buchschn/>

Observers using HARPS-N in Visitor Mode should prepare their OBs in advance using the HARPS-N Instrument Package, which is automatically downloaded once NSTS is started and the Offline Mode is selected from the menu. OBs prepared at the observer’s home institution can be quickly imported in the NSTS running at telescope console and be ready for execution.

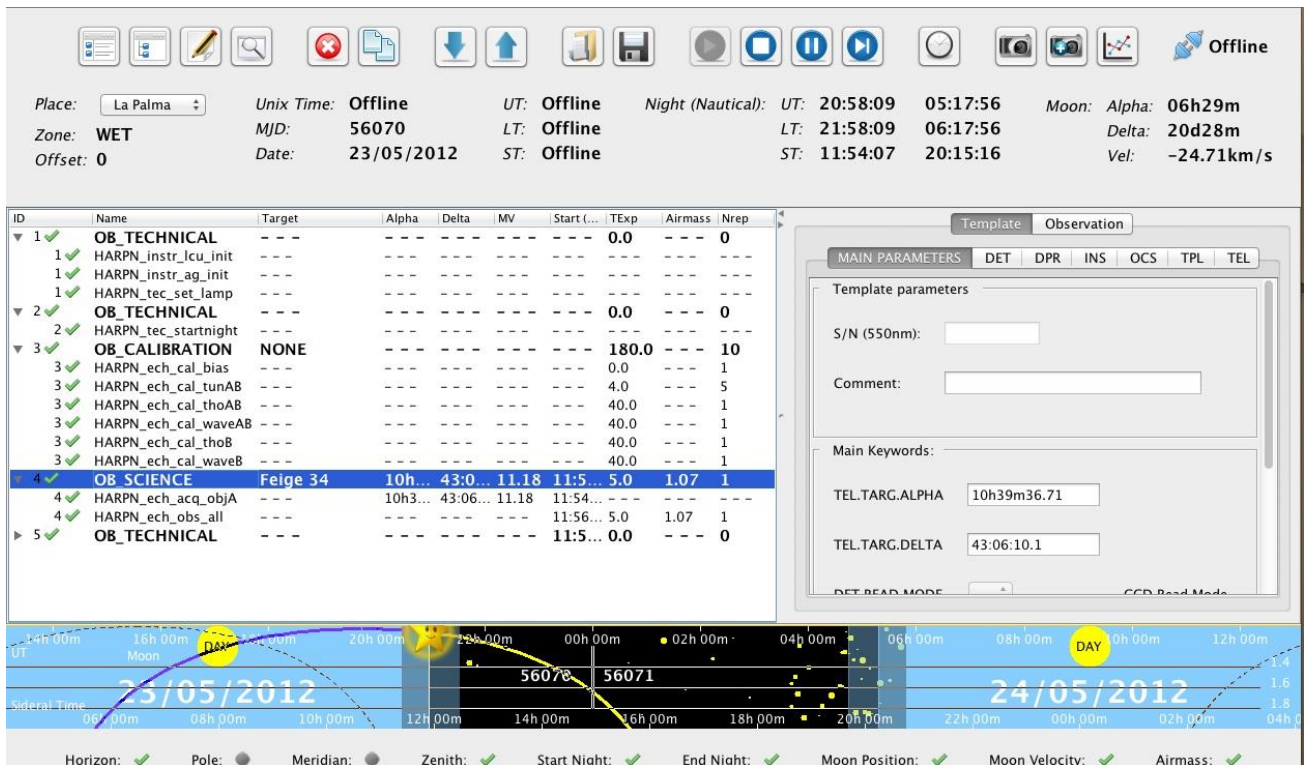

Figure 23 - Short Term Scheduler

For a description of all HARPS-N templates and the parameters selectable with NSTS consult the “HARPS-N Template Reference Guide”

In Table 9 is shown the fibers illumination scheme as a function of the template used is shown.

Table 9 - Fiber illumination scheme as a function of the template used

HARPN_ech_acq_objA	Star	Dark
HARPN_ech_acq_objAB	Star	Sky
HARPN_ech_acq_thosimulth	Star	ThAr lamp 2
HARPN_ech_acq_wavesimulth	Star	FB
HARPN_ech_cal_thoAB	ThAr lamp 1	ThAr lamp 2
HARPN_ech_cal_thoA	ThAr lamp 1	Dark
HARPN_ech_cal_thoB	Dark	ThAr lamp 2
HARPN_ech_cal_tun A	Tungsten	Dark
HARPN_ech_cal_tun B	Dark	Tungsten
HARPN_ech_cal_tunAB	Tungsten	Tungsten
HARPN_ech_cal_waveA	Wave A	Dark
HARPN_ech_cal_waveB	Dark	Wave B
HARPN_ech_cal_waveAB	ThAr lamp 1	Wave B

4.3 Overheads

The pipeline overheads are for reference only, observations can proceed without the need for waiting the pipeline results. Thorium lamps pre-heating overhead have to be considered before the start of the afternoon calibrations.

telescope preset included dome rotation	8 min (upper limit for large, more than 180deg, dome rotation) 2 min (typical for new pointing within a few degrees from the previous position)
centering of object on the fibre, start of guiding	1 – 2 minutes (depends by the user)
Initialization	LCU = 3:15 minutes AG = 1 minute
StartNight/EndNight	22 seconds
instrument configuration	8 seconds
readout time (included FITS headers generation)	34 sec
Standard calibration	< 12 minutes
minimum time between successive exposures	34 sec
telescope focusing (at the beginning of the night, or if the condition are critical)	8-10 minutes
DRS pipeline for thosimul without RV computation	
DRS pipeline for objA without RV computation	
DRS pipeline for objAB without RV computation	
DRS pipeline extra time for each RV calculation	
ThAr lamp pre-heating (once at the beginning of the night)	5 min minimum, 10 min recommended, 15 min maximum

4.3.1 Fast time series observations (asteroseismology)

The shortest recommended exposure time with the HARPS-N shutter is 10 seconds, while the shortest recommended exposure in simultaneous thorium exposure mode is 20 seconds (minimum exposure time to achieve a 15 cm/sec instrument drift tracking). For each CCD frame there is an overhead (readout, attachment of fits header etc.) of ~35 seconds (readout mode 500 kpx/sec). With 20 sec exposure time on sky, 55 seconds cycles have been achieved. The pipeline presently implemented is able to reduce this flood of data in nearly real-time. Reduction of one frame lasts about 24 seconds, the pipeline: no frames will be left behind.

4.4 The HARPS-N Exposure Time and Spectral Format Calculator

The HARPS-N Exposure Time Calculator (ETC) models the instrument and detector in their different configurations. It can be used to compute the detailed spectral format (wavelength and order number as function of position on the detector) and the expected SNR for the specified target under given atmospheric conditions as a function of exposure time. It is available via the the Geneve University web pages at: <http://obswww.unige.ch/~buchschn/NSTS/NSTS.jnlp>

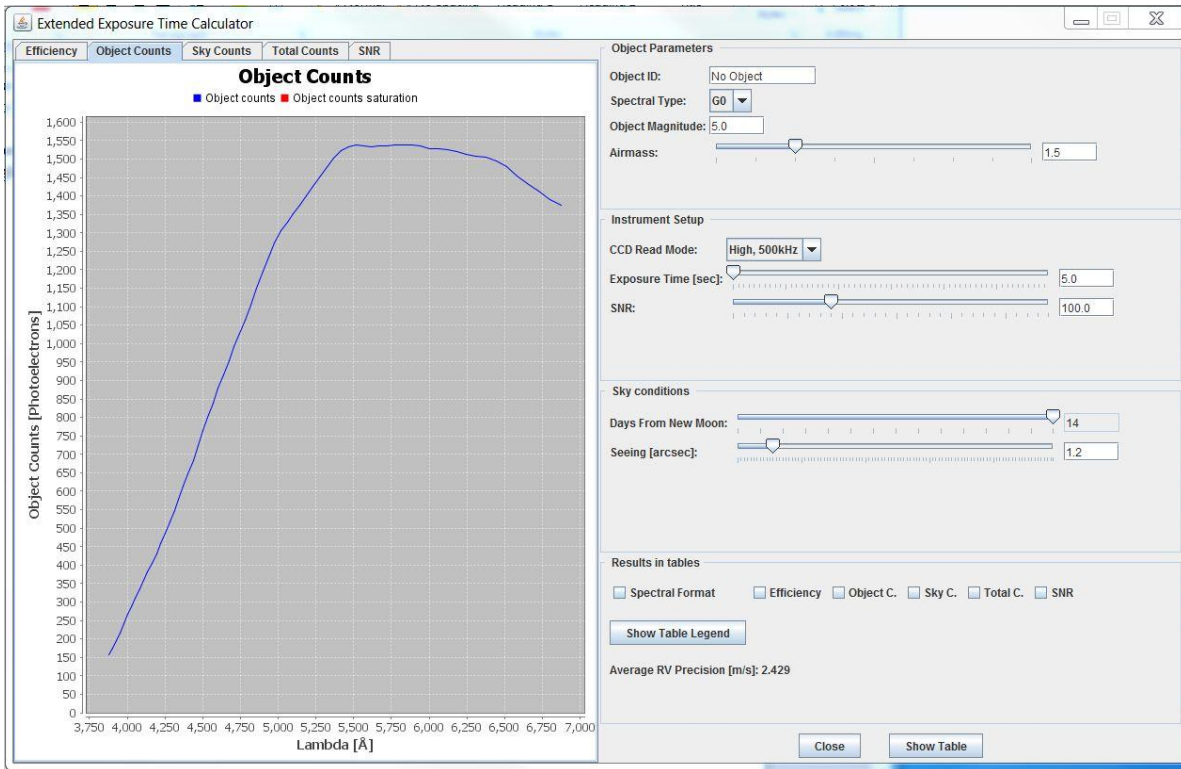

Figure 24 - Exposute Time Calculator (ETC)

5 Observing with HARPS

More information on the startup procedures and on the use of HARPSN are reported in:

- HARPS-N Quick Start guide (TNG-MAN-HAN-0001)
- HARPS-N Operation Guide (TNG-MAN-HAN-0003)

5.1 The Observation blocks preparation

From the NSTS the observer can prepare the sequence of observation blocks of the night.

The target can be inserted directly in the NSTS or by using a catalog file that contains the objects

information. The format of the catalog file is an ascii file and the fields separator is a TAB (ascii code = 9).

The fields of the catalog are shown in Table 1 **Error! Reference source not found.**, the mandatory fields are shown in bold format.

An example of catalog file is shown in the HARPS-N webpage:

(<http://www.tng.iac.es/instruments/harps/data/SpStdHARPSN.cat>)

Table 10- catalog file entries

name	object code
alpha	right ascension (nn:nn:nn.nn)
delta	Declination (nn:nn:nn.nn)
mualpha	proper motion alpha(arcsec/year)
mudelta	proper motion delta (arcsec/year)
mv	magnitude V
radvel	mean radial velocity (KM/sec)
snr	Signal/Noise (550nm)
spectr	spectral type for the mask(F9, G2, G8, G9, K2, K6, M0, M2, M3, M4, M5)
remarks	Remarks
acquisition	Acquisition template (es. HARPN_ech_acq_objA)
equinox	Equinox
progid	program identifier (es. TAC_xx)
piname	PI name
exptime	Exposure time

5.2 Before the night

Depending on the observing method applied (simultaneous Thorium reference, classical fibre spectroscopy) different sets of calibration exposures need to be taken before the start of the science observations.

For all three methods it is necessary to take a series of calibration exposures (Bias, Tungsten, Thorium) because they are needed for the pipeline to produce optimum results. A calibration OB (“OB Standard Calibration”) is available in the NSTS and ready for execution to take these exposures.

5.3 During the night

5.3.1 Target acquisition, guiding, focusing

Target acquisition is done by the FEU. The object is centered on the entrance of the science fibre and kept there by an automatic dynamic centering algorithm. The guiding accuracy may introduce radial velocity errors but considered the use of octagonal fibers the expected errors are well below the accuracy attainable with HARPS. Users with crowded fields, close binaries, faint objects etc., should prepare finding charts. The guide camera can guide on stars of magnitude up to 15.5 (seeing 1.0 arcsec) (TBC).

In the fibre AB spectroscopy mode (object + sky) the observer should verify that the sky fibre is not contaminated by light from other sky objects. This should in the first place be done by watching the count rate of the exposure meter (photometer B).

It is important that the telescope is well focused at all times. It is recommended to have a through focus sequence performed using the focus template when the image quality observed on the guiding camera deteriorates significantly, or whenever there is a significant temperature change (few °C).

5.3.2 Pointing restrictions

The telescope dome shall be closed when any of the following weather conditions occur (on the “TNG Weather Panel” webpage)

<http://tngweb.tng.iac.es/weather/>

- Wind speed > 15 m/sec
- Humidity >85% ()
- Temperature within 2° of dew point

The telescope shall not be pointed into the wind when the wind speed is more than 10 m/sec

The TO will make the decision to close the dome as necessary. VAs should accept the decision since the reason is exclusively the protection of the telescope from damage. At any rate, in case of a disagreement the dome should first be closed and subsequently the VA may take up the issue with the support astronomer and finally the TNG director - though it is highly unlikely that the decision will be altered.

The dome may be re-opened if weather conditions improve and stay below the operating limits for at least 30 minutes. This waiting period is particularly important in case of humidity. The TO will further confirm that the condensation on the dome has completely evaporated.

5.3.3 Night calibrations

Night calibrations in addition to the calibration observations taken before the start of the science observations are only necessary when using the template without simultaneous reference.

5.3.4 Real-time display

Raw data coming from the instrument are displayed on a DS9 Display.

5.4 Observing very faint stars

As explained in section 3.1 a variable neutral density filter is used to balance the intensity of the Thorium-Argon calibration spectrum depending on the exposure time. This works correctly for exposure times up to 6000 s.

For very faint stars which require even longer exposures this may lead to an overexposure of the calibration spectrum with contamination of the stellar spectrum. As the ultimate accuracy of HARPS-N (1 m/s) will usually not be reached on such faint stars, it is recommended not to use the simultaneous Thorium reference method but to rely on the excellent short-term stability of HARPS-N and take separate wavelength calibration exposures immediately before and after the science exposure to interpolate and remove possible instrumental drift errors. The additional time spent on this is negligible given the long science integration.

5.5 Asteroseismology

Asteroseismology observers need to pay special attention to the guiding behavior (continuous control

by the observer). Also, it is recommend to use the NSEQ parameter to produce exposure multiplication instead of duplicating OBs. This method will save useless re-acquisition of the star and thus produce a considerable gain of time.

5.6 End of the night

No further calibrations are necessary after the end of the science observations. To prolong the life of the calibration lamps HARPS-N is switched to the so-called “Dark” mode. All lamps still in use at the time are thereby switched off and the dust cover in the fibre adapter is put in place to protect the fibre entrance. All electronics are in stand-by, all internal house-keeping functions (temperature and pressure control, logging) continue to operate.

6 The Reduction of HARPS-N Data

6.1 The HARPS-N data reduction pipeline

Every HARPS-N frame is processed by the online pipeline. Depending on the observation, the pipeline uses different reduction recipes. Results of the reduction are:

- Extracted spectrum (all modes)
- Precise radial velocity
- Cross correlation function

The pipeline output is available immediately after the processing is finished (see section 4.3). It can then be transferred to the offline workstation for further analysis. It can also be saved to disk and CD/DVD using the “Data Archiving Unit” (see chapter 7) available with HARPS. This is typically done next morning by the telescope operator or the Data Handler Administrator. The visitor is not requested to produce a backup of the raw data and of the pipeline products.

6.2 High accuracy radial velocities

The reduction concept applied by the pipeline for the calculation of high accuracy radial velocities using the Thorium reference method is described in the paper “ELODIE: A spectrograph for accurate radial velocity measurements” by Baranne, Queloz, Mayor et al., A&AS 119,373(1996).

In order to get the full performance of the pipeline with respect to the determination of accurate radial velocities, the following items should be noted:

1. to achieve an accurate solar system barycentric Radial velocity, correction of 1 m/s, the target coordinates must be known to within $6''$ including proper motion
2. the RV of a star needs to be known to within 1-2 km/s to give the pipeline a reasonable starting point for the RV computation.

7 Data products and archiving

7.1 Data products

HARPS-N writes FITS files with extensions containing the data of both CCDs. The size of one raw data file is approximately 32Mb.

Data naming rules are summarized in A.1 Data naming rules pag. 46)

By default the data products of the online pipeline are archived as well. Following is an example of the files that are included in the archiving of one exposure:

7.1.1 Raw data file

HARPN.YYYY-MM-DDTHH-MM-SS.SSS.fits (raw spectra data – Full image with header)
 A- HARPN.YYYY-MM-DDTHH-MM-SS.SSS.fits (Autoguide full image)
 E- HARPN.YYYY-MM-DDTHH-MM-SS.SSS.fits (autoguide integrated box image)
 G- HARPN.YYYY-MM-DDTHH-MM-SS.SSS.tbl (exposure meter data – ascii file)

7.1.2 Reduced data file

- Cross correlation function summary table with extracted RV for each order, for M mask
HARPN.YYYY-MM-DDTHH-MM-SS.SSS_ccf_M_A.tbl
- Cross correlation function matrix in fits format for mask M:
HARPN.YYYY-MM-DDTHH-MM-SS.SSS_ccf_M_A.fits
- 2D extracted spectrum, one row per order:
HARPN.YYYY-MM-DDTHH-MM-SS.SSS_e2ds_A.fits
- 1D extracted full spectrum, wavelength calibrated, in the solar system barycentric frame:
HARPN.YYYY-MM-DDTHH-MM-SS.SSS_s1d_A.fits
- Bisector from the cross correlation computed with a MASK mask
HARPN.YYYY-MM-DDTHH-MM-SS.SSS_bis_MASK_A.fits
- Geometry of the order: This fits file contains the FWHM of each order for each row
HARPN.YYYY-MM-DDTHH-MM-SS.SSS_fwhm-order_A.fits
- Geometry of the order: This fits file contains the x position of the center of the order
HARPN.YYYY-MM-DDTHH-MM-SS.SSS_loco_A.fits
- Flat Field measurement: this fits file contains the blaze for each order
HARPN.YYYY-MM-DDTHH-MM-SS.SSS_blaze_A.fits
- Flat Field measurement: this fits file contains the flat for each order
HARPN.YYYY-MM-DDTHH-MM-SS.SSS_flat_A.fits
- Wavelength Calibration: fits file with the wavelength solution (wavelength of each order for each pixel)
HARPN.YYYY-MM-DDTHH-MM-SS.SSS_wave_A.fits

- Wavelength Calibration: ascii file with a list of all thorium lines detected with information about FWHM, sig, etc.
HARPN.YYYY-MM-DDTHH-MM-SS.SSS_lines_A.rdb
- Wavelength Calibration: Ascii file with a sample of Th lines intensities and FWHM (only for TH calibration frames):
HARPN.YYYY-MM-DDTHH-MM-SS.SSS_spot_thAB.tbl
- Fits file with the Reduced tungsten data file (Full image Flat Field)
HARPN.YYYY-MM-DDTHH-MM-SS.SSS_order_profile.fits
- Fits file with the extracted tungsten data file (Flat Field)
HARPN.YYYY-MM-DDTHH-MM-SS.SSS_lamp_A.fits

Other summary tables are produced at the end of each night:

- **Calibration: Ascii file with Bias table**
cal_BIAS_result.tbl: Bias table
- Flat Field measurement: this ascii file contains parameter of 4 orders
cal_FF_result_HARPN.tbl
- Wavelength Calibration: ascii file with the parameters of the thorium wavelength calibration
cal_TH_result_HARPN.tbl
- Wavelength Calibration: ascii file with the parameters of the FP wavelength calibration
cal_WAVE_result_HARPN.tbl: Fabry-perot table (for wavelength calibrations)
- RV measurement: Ascii file with the Th lines drift in m/s measured on fiber B, filled only in the simultaneous Thorium reference mode
drift_result.tbl
- RV measurement: Ascii file with results of the CCF, with measured RV and RV sigma.
CCF_results.tbl

7.2 Data archiving

7.2.1 TNG and Trieste archives

HARPS-N raw data are stored locally at TNG and in the central Trieste Science Archive.

7.2.2 TNG data logging

The user can look up locally the logbook of the observation through the TNG archive logbook (see Figure 25):

<http://alexandria.tng.iac.es/logbook/>

Archive Logbook

Date	Instruments	Group by	Input	FITS Index
<input type="text" value="2012-09-09"/> (YYYY-MM-DD)	<input type="checkbox"/> LRS <input type="checkbox"/> SARG <input type="checkbox"/> NICS <input type="checkbox"/> OIG <input checked="" type="checkbox"/> HARPN	<input checked="" type="radio"/> Instrument <input type="radio"/> Datetime	<input type="button" value="Browse"/> <input type="button" value="Show Today"/>	File: <input type="text"/> <input type="button" value="Sfogliala..."/> <input type="button" value="Upload"/> Operation is very simple, download the program, run it on a directory and it will create a file which you use to submit on this form, and you'll get a HTML output table 'a-la' Logbook. Here you can see the manual of genfitinput .

(2012-09-09 10:00:00) ~ (2012-09-10 09:59:59)

HARPN							56 matched
Image	Observ. Type	Program	Object	UT Date	Coord + PA	Expo. Time	Air Mass
HARPN_2012-09-10T06-15-20.295.FITS	CALIB	CALIB		2012-09-10T06:15:20.295 06:15:20	[02:10:25] [29:48:35]	20.0 (0.0)	0.0
HARPN_2012-09-10T06-03-47.451.FITS	SCIENCE	GAPS		2012-09-10T06:03:47.451 06:03:47	[02:10:26] [29:48:31]	600.0 (0.0)	1.13
HARPN_2012-09-10T05-47-45.089.FITS	SCIENCE	GAPS		2012-09-10T05:47:45.089 05:47:45	[01:58:13] [37:32:40]	800.0 (0.0)	1.13
HARPN_2012-09-10T05-25-23.462.FITS	SCIENCE	GAPS		2012-09-10T05:25:23.462 05:25:23	[01:57:23] [37:36:23]	1200.0 (0.0)	1.11
HARPN_2012-09-10T05-00-00.176.FITS	SCIENCE	GAPS		2012-09-10T05:00:00.176 05:00:00	[01:58:14] [37:15:17]	1200.0 (0.0)	1.07
HARPN_2012-09-10T04-40-42.952.FITS	SCIENCE	GAPS		2012-09-10T04:40:42.952 04:40:42	[01:44:31] [44:27:33]	900.0 (0.0)	1.08
HARPN_2012-09-10T04-17-56.745.FITS	SCIENCE	GAPS		2012-09-10T04:17:56.745 04:17:56	[01:57:53] [37:27:28]	1200.0 (0.0)	1.03
HARPN_2012-09-10T03-53-58.335.FITS	SCIENCE	GAPS		2012-09-10T03:53:58.335 03:53:58	[01:56:23] [37:37:37]	1200.0 (0.0)	1.02
HARPN_2012-09-10T03-27-45.982.FITS	SCIENCE	GAPS		2012-09-10T03:27:45.982 03:27:45	[01:55:58] [37:40:18]	1400.0 (0.0)	1.01
HARPN_2012-09-10T03-14-47.195.FITS	CALIB	CALIB		2012-09-10T03:14:47.195 03:14:47	[00:16:21] [16:39:08]	20.0 (0.0)	1.06

Figure 25 - TNG archive loogbook

7.2.3 Use of archived HARPS-N data

For convenient archiving of raw observation data and pipeline products dedicated Data Archiving software is available at Trieste Science Archive. It allows the observers to get the observations data, choosing the data product they want (raw data, reduced data or both, log files).

HARPS-N data can be requested from the Trieste Science Archive:

<http://ia2.oats.inaf.it/archives/tng>

Data taken by observers in Visitor or Service Mode are subject to the usual proprietary period of 1 year.

According to the Agreement between GTO consortium and the HARPS-N Consortium the data taken by the Consortium during their Guaranteed Time are subject to special protection:

- Raw data and reduced spectra ($I=f(\lambda)$) in the Earth reference frame at the time of the observation will be made public one year after observations
- All raw data and radial velocity measurements obtained by the Consortium will be made public one year after the end of the 5 year Guaranteed Time period.

In practice this means that data obtained by the Consortium can be requested from the TNG Science Archive as usual one year after the observations. However, in order to make recovery of precise radial velocities impossible, the keywords containing information about the exact time of the observations will be filtered from all file headers (raw and reduced) by the Archive during the de-archiving process. This filtering will be applied until one year after the end of the 5 year Guaranteed Time period.

INAF
CENTRO ITALIANO ARCHIVI ASTRONOMICI

Main Menu

- Home
- Main Archives
- TNG Archive
 - IA2-TNG archive**
 - OLD IA2-TNG Archive
 - Image Gallery
- LBT Archive
- ASIAGO archive
- REM Archive
- ITVO Archive
- BaSTI Archive
- VO Services
- VO-Dance
- Vodka
- Project involved
- GAIA
- GAPS
- PESSTO
- Hosted Archives
- Molero ULP
- Nonino ATGC
- Additional info
- Italian Archives
- VObs.it Project
- Useful Links
- Search
- Contact IA2

IA2-TNG archive

TNG ARCHIVE@IA2

Help & FAQ

Proprietary data retrieval form:

Program:

Password:

Enter (Proprietary)

Public data retrieval form:

Public data are:
- all metadata;
- calibration images;
- images outside Proprietary period.

Enter (Public)

Powered by IA2 (INAF - Trieste Astronomical Observatory)
For any problem, please contact: [IA2 team](#)

Figure 26 - TNG national Archive

Appendix A

Description of archived HARPS data

A.1 Data naming rules

The raw frames are stored in FITS format by the DFS with the ESO-VLT standard naming rules:

HARPN.YYYY-MM-DDTHH-MM-SS.SSS.fits with YYYY-MM-DD and HH-MM-SS.SSS being respectively the date and time of the start of the observation. Raw frames are written in extended fits format, each CCD being on a different plane of the frame.

Pipeline products are stored in FITS format with the same generic names plus an additional suffix describing its format (see next section for details) and the specific fibre name (A or B). For example:

HARPN.YYYY-MM-DDTHH-MM-SS.SSS_E2DS_A.fits is an E2DS format image of the fibre A product by the DRS derived from the HARPN.YYYY-MM-DDTHH-MM-SS.SSS.fits raw frame.

Tables in ASCII format are also produced by the DRS.

The raw data are stored in */data/raw* and the reduced are stored in */data/reduced*.

The relevant log-books of the DRS is named DRS-drs32.hn.tng.iac.es.YYYY-MM-DD. It is stored with all the other logs in the */data/msg* directory.

A.2 Data formats

The raw frame corresponds to a 4096×4096 integer (33554432 bytes) matrix written on disk in extended FITS format. The following generic descriptors are used by the DRS:

MJD-OBS	Modified Julian Day start [float]
EXPTIME	Total integration time (s) [float]
DATE-OBS	Date and Time of observation [string]
RA	RA of the target [float]
DEC	DEC of the target [float]
EQUINOX	Equinox of observation [float]

The DRS needs as well the following HIERARCH ESO descriptors:

TNG DET READ SPEED	CCD Readout mode (speed, port and gain) [string]
DET OUTi GAIN	Conversion from electrons to ADUs of port i [float]
DET OUTi RON	Readout noise of port i (e-) [float]
DET WIN1 DIT1	Actual sub-integration time (s) [float]
DET WIN1 DKTM	Dark current time (s) [float]
DET DPR CATG	Observation category [string]
DET DPR TYPE1	Observation type [string]
INS DET1 TMMEAN	Normalized mean exposure time on fibre A [float]

INS DET2 TMMEAN	Normalized mean exposure time on fibre B [float]
INS OPTI5 NAME	Lamp name on fibre A [string]
INS OPTI6 NAME	Lamp name on fibre B [string]
OBS NAME	OB Name [string]
OBS START	OB Start Date and time [string]
TPL ID	Template signature ID [string]
OBJECT TYPE	What is on fibre A and B [string]
OBJECT SP	Object spectral type [string]
OBJECT RV	Object expected RV [string]
TEL TARG RADVEL	Object expected RV [string]

Appendix B

List of acronyms

ADC Atmospheric Dispersion Compensator

AG Auto-Guider

CCD Charge Coupled Device

CCF Cross Correlation Function

CFC Continuous Flow Cryostat

CU Calibration Unit

DFS Data Flow System

DRS Data Reduction Software

E2DS Extracted 2-Dimensional Spectrum

ETC Exposure Time Calculator

FEU Front End Unit

FITS Flexible Image Transport System

FWHM Full Width at Half Maximum

HARPS-N High Accuracy Radial velocity Planet Searcher in the North hemisphere

ND Neutral Density

NSTS New Short Time Scheduler

OB Observing Block

RV Radial Velocity

SA Support Astronomer

SNR Signal to Noise Ratio

TBC To Be Confirmed

TBD To Be Defined

ThAr Thorium Argon

TNG Telescopio Nazionale Galileo

TO Telescope Operator

VA Visiting Astronomer